

# ! WARNING :

- All the pneumatic tools should only be used as hand operated tools. They are powered by compressed air and are not insulated against electric shock.
- Always turn off the air supply and disconnect the air hose before changing or replacing any inserted tool and accessory.
- Before using these tools, make sure that all couplings and plugs are securely fastened. Air hoses which are under pressure may lash out when disconnecting, that can lead to serious injury!
- High sound levels may cause hearing damage.
- Always wear hearing protection when operating this tool.
- Wearing eye/face protection can reduce the danger of high-speed materials being emitted from the tool.
- Make sure that the direction of the spark generated from the cutting wheel grinding wheel or shank stone is properly directed so as to not create a hazard..

- Always wear gloves to reduce risk
- User must wear proper clothing.
- Loose clothing, long hair, stings, straps, belts and jewelry should not be worn when operating this tool.
- Long periods of prolong use will cause fatigue.
- Periodic breaks are recommended for user safety.
- It is recommended to stop operating the tool whenever discomfort, tingling or pain occurs during use.
- Make sure there is no gas or combustible material stored near the tool when servicing, changing insert tools, or storage.
- Wearing proper breathing protection to avoid inhale dust or handling debris from working process, which can be harmful to the health.



AUTHENTIC POWER



# LEVEL IDENTIFICATION

## LEVEL

The air tools in this section have been categorized into three distinctive levels for user convenience (for reference only).



### Efficiency / Performance

Easy to use to handle tasks quickly, these tool embody efficiency and performance.



### Strength

Tools provide high torque force, superior grinding power and high cutting energy.



### Endurance

Built to last, product longevity and low failure rate are characteristics associated with these tools.

## APPLICATION

Application icons have been designed to provide visual references that suggest industry specific features or usability. These application icons are for reference only.



Automotive



Industry



Shipbuilding



Motorcycle



Agriculture



Aviation

# CONTENT

- 04 - NEW PRODUCT
- 08 - AIR IMPACT WRENCH
- 20 - AIR RATCHET WRENCH
- 24 - AIR DIE GRINDER
- 29 - AIR ANGLE GRINDER
- 34 - **AIR SANDER / AIR SQUARE SANDER**
- 40 - AIR CUTTING TOOLS
- 46 - AIR DRILL
- 52 - AIR SCREWDRIVER
- 57 - SPRING BALANCER
- 58 - AIR HAMMER
- 62 - AIR HYDRAULIC RIVETER
- 66 - **AIR NAILER / AIR STAPLER**
- 68 - AIR GREASE GUN
- 70 - AUTO REPAIR TOOL
- 77 - SANDBLASTING GUN
- 78 - FILTER REGULATOR LUBRICATOR
- 80 - AIR HOSE REEL
- 81 - **TORQUE WRENCH**
- 87 - IMPACT SOCKET
- 105 - **DISPLAY STAND / DISPLAY CASE**
- 108 - ACCESSORIES
- 116 - **AIR ADAPTOR / QUICK COUPLINGS**
- 118 - POWER BIT
- 120 - MERCHANDISE
- 122 - CORDLESS TOOLS



# NEW PRODUCT

★★★ **NC-3231Q**  
3/8" DRIVE Twin Hammer Type  
Air inlet : 1/4"



★★★ **NC-4117**  
1/2" DRIVE Pin clutch Type  
Air inlet : 1/4"



★★★ **NC-4277Q**  
1/2" DRIVE Twin Hammer Type  
Air inlet : 1/4"



★★★ **NC-4299Q**  
1/2" DRIVE Twin Hammer Type  
Air inlet : 1/4"



Square Drive	Bolt Capacity	Torque Range	Max Torque		Free Speed	Avg. Air Consumption	Air Pressure	Overall Length	Net Weight		Air Hose	Sound Pressure	Vibration Level
Inch	Inch (mm)	FT-LB (Nm)	FT-LB	Nm	R.P.M	CFM (L/min)	PSI (bar)	Inch (mm)	LBS	kg	Inch	dBA	m/s <sup>2</sup>
NC-3231Q	3/8"	1/2"(13)	200-350(271-475)	450 610	8000	4.2(129)	90(6.3)	6-5/16"(160)	2.8	1.3	3/8"	83.0	3.0
NC-4117	1/2"	3/4"(18)	200-550(271-746)	700 949	7000	5.4(153)	90(6.3)	8"(205)	4.3	1.95	3/8"	90.0	2.5
NC-4277Q	1/2"	1"(25)	200-800(271-1088)	1150 1564	7000	4.8(136)	90(6.3)	6"(155)	4.4	2	3/8"	85.0	4.5
NC-4299Q	1/2"	3/4"(19)	150-500(204-680)	800 1088	8500	4.0(113)	90(6.3)	7-1/2"(194)	4.6	2.1	3/8"	85.0	3.2

★★★ **NE-2905**

1/4" DRIVE Air inlet : 1/4"

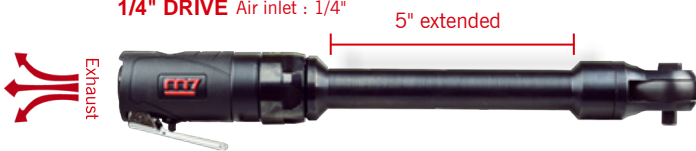

★★★ **NE-3310 / 4310**

3/8" & 1/2" DRIVE Air inlet : 1/4"



★★★ **NE-2803 / 3803**

1/4" & 3/8" DRIVE Air inlet : 1/4"



★★★ **NE-3808 / 4808**

3/8" & 1/2" DRIVE Air inlet : 1/4"



Square Drive	Torque Range	Max Torque		Free Speed	Avg. Air Consumption	Air Pressure	Overall Length	Net Weight		Air Hose	Sound Pressure	Vibration Level
Inch	FT-LB (Nm)	FT-LB	Nm	R.P.M	CFM (L/min)	PSI (bar)	Inch (mm)	LBS	kg	Inch	dBA	m/s <sup>2</sup>
NE-2905	1/4"	5-15(7-20)	22 30	300	3.0(85)	90 (6.3)	11-1/2"(290)	1.85	0.84	3/8"	89	4.4
NE-3310	3/8"	15-55(70-75)	70 95	160	4.0(113)	90 (6.3)	20-7/8"(530)	3.85	1.75	3/8"	82	1.2
NE-4310	1/2"	15-55(20-75)	70 95	160	4.0(113)	90 (6.3)	20-7/8"(530)	3.85	1.75	3/8"	82	1.2
NE-2803	1/4"	5-15(7-20)	35 47.6	300	3.6(102)	90 (6.3)	8-1/2"(220)	1.39	0.63	3/8"	92.8	3.2
NE-3803	3/8"	5-30(7-40)	35 47.6	300	3.6(102)	90 (6.3)	8-1/2"(220)	1.39	0.63	3/8"	92.0	3.2
NE-3808	3/8"	10-55(13.5-74)	80 108.8	180	4.0(113)	90 (6.3)	12"(300)	2.77	1.26	3/8"	95.0	3.6
NE-4808	1/2"	10-55(13.5-74)	80 108.8	180	4.0(113.28)	90 (6.3)	12"(280)	2.77	1.26	3/8"	95.0	3.6

NEW PRODUCT





## QE-6030 QE-6030L

Air Right Angle Drill / Threaded type  
Air inlet : 1/4"



## QE-6020 QE-6020L

Air Right Angle Drill / Threaded type  
Air inlet : 1/4"



## QE-6010 QE-6010L

Air 45° Angle Drill / Threaded type  
Air inlet : 1/4"



	Spindle Size	Free Speed	Motor	Air Inlet	Overall Length	Avg. Air Consumption	Air Pressure	Net Weight		Air Hose	Sound Pressure	Vibration Level
		R.P.M	hp	kg/cm <sup>2</sup>	inch( mm )	CFM (L/min)	PSI (bar)	LBS	kg	Inch	dBA	m/s <sup>2</sup>
QE-6030	1/4"-28	4000	0.40	1/4"	9-1/2"(240)	3.0(84)	90(6.3)	1.4	0.64	3/8"	81.5	<2.5
QE-6030L	1/4"-28	4000	0.40	1/4"	12-1/8"(308)	3.0(84)	90(6.3)	1.65	0.75	3/8"	81.5	<2.5
QE-6020	1/4"-28	4000	0.40	1/4"	9-1/2"(240)	3.0(84)	90(6.3)	1.4	0.64	3/8"	81.5	<2.5
QE-6020L	1/4"-28	4000	0.40	1/4"	12-1/8"(308)	3.0(84)	90(6.3)	1.65	0.75	3/8"	81.5	<2.5
QE-6010	1/4"-28	4000	0.40	1/4"	10"(256)	3.0(84)	90(6.3)	1.4	0.64	3/8"	81.5	<2.5
QE-6010L	1/4"-28	4000	0.40	1/4"	13-1/8"(333)	3.0(84)	90(6.3)	1.65	0.75	3/8"	81.5	<2.5



## SC-371

AIR HAMMER  
Do not include the chisel



## SC-371C

AIR HAMMER  
include the chisel



### HAMMER CHISEL

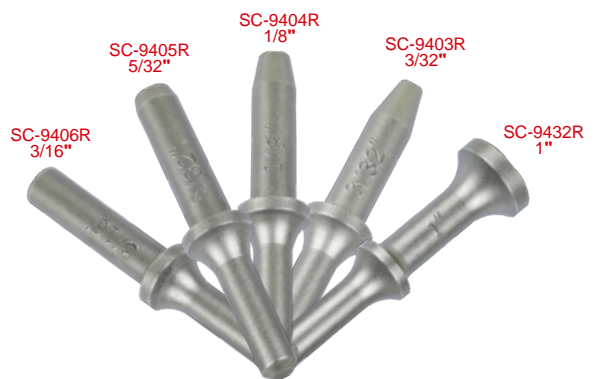

	Shank Size	Stroke Length	Blow Minute	Avg. Air Consumption	Air Pressure	Overall Length	Net Weight		Air Hose	Sound Pressure	Vibration Level
	inch(mm)	mm	bpm	CFM (L/min)	PSI (bar)	Inch (mm)	LBS	kg	Inch	dBA	m/s <sup>2</sup>
SC-371	3/8"(10.2)	62.5	3000	7.8(180)	90(6.3)	7-1/8"(180)	3.7	1.7	3/8"	95.0	8.8

# NEW PRODUCT

★★  GTW-201030

**1/4" Digital Torque Wrench**

Accuracy: clockwise +/- 1.5% counterclockwise +/- 2.5%



★★  GTW-306135

**3/8" Digital Torque Wrench**

Accuracy: clockwise +/- 1.5% counterclockwise +/- 2.5%



★★  **GTW-406135 / GTW-410200**

**1/2" Digital Torque Wrench**

Accuracy: clockwise +/- 1.5% counterclockwise +/- 2.5%



★★  GTW-417340

**1/2" Digital Torque Wrench**

Accuracy: clockwise +/- 1.5% counterclockwise +/- 2.5%



★★  **GTW-606060**

**3/4" Digital Torque Wrench**

Accuracy: clockwise +/- 1.5% counterclockwise +/- 2.5%



★★  **GTW-610100 / GTW-810100**

**3/4" / 1" Digital Torque Wrench**

Accuracy: clockwise +/- 1.5% counterclockwise +/- 2.5%



★★  **GTW-930 / GTW-940 / GTW-941**

**3/8" / 1/2" / 1/2" Digital Torque Wrench**

Accuracy: clockwise +/- 1.5% counterclockwise +/- 2.5%



	Drive	Torque Range (Nm)	Torque Range (ft-lb)	Indicator	Torque Adjusting	D mm	H mm	L mm	Weight kg
GTW-201030	1/4"	1.5-30	1.11-22.13	LCD	Digital	38	38	410	0.71
GTW-306135	3/8"	6.8-135	5.0-99.6	LCD	Digital	38	38	432	0.84
GTW-406135	1/2"	6.8-135	5.0-99.6	LCD	Digital	38	41	455	1.07
GTW-410200	1/2"	34-340	20.7-154.9	LCD	Digital	38	41	566	1.2
GTW-417340	1/2"	17-340	12.5-250.8	LCD	Digital	38	41	662	1.4
GTW-606060	3/4"	60-600	44.3-442.5	LCD	Digital	63	58	943	3.8
GTW-610100	3/4"	100-1000	73.8-737.6	LCD	Digital	63	58	1235	4.6
GTW-810100	1"	100-1000	73.8-737.6	LCD	Digital	69.5	70	1235	4.9
GTW-930	3/8"	6.8-135	5.0-99.6	LCD	Digital	32	31.8	361	0.77
GTW-940	1/2"	10-200	7.4-147.5	LCD	Digital	32	31.8	361	0.77
GTW-941	1/2"	17-340	12.5-250.8	LCD	Digital	32	31.8	361	0.77



# ★★★ RA-801ET

**AIR SCREWDRIVER**  
**EXTERNAL ADJUSTABLE** Screw Capacity : M4  
 Air inlet : 1/4"

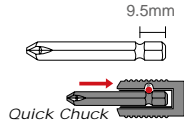

	Bit Size	Torque Range	Free Speed	Avg. Air Consumption	Air Pressure	Overall Length	Net Weight	Air Hose	Sound Pressure	Vibration Level
	inch(mm)	FT-LB(Nm)	R.P.M	CFM (L/min)	PSI (bar)	Inch (mm)	LBS kg	Inch	dBA	m/s <sup>2</sup>
<b>RA-801ET</b>	1/4"(6.35)	13.2-23(1.5-2.6)	1700	17.5(496)	90(6.3)	7-4/5"(198)	2.65 1.20	1/4"	93.6	1.35

## 1/2" ME471T

**Star Bit Socket**

- 1/2" Drive Deep Length
- 6 Points
- Inch Size



M7 NO.	T	D1	D2	L	g
		mm	mm	mm	
ME471T10	T10	6	24.7	78	71
ME471T15	T15	6	24.7	78	71
ME471T20	T20	6	24.7	78	68
ME471T25	T25	6	24.7	78	74
ME471T27	T27	6	24.7	78	76
ME471T30	T30	6.5	24.7	78	76
ME471T40	T40	7.5	24.7	78	81
ME471T45	T45	8.5	24.7	78	85
ME471T47	T47	8.5	24.7	78	85
ME471T50	T50	9.5	24.7	78	87
ME471T55	T55	12	24.7	78	106
ME471T60	T60	14	24.7	78	118
ME471T70	T70	16	24.7	78	135
ME471T80	T80	18	24.7	78	155

## 3/4" MA641M

**4 POINT SQUARE IMPACT SOCKET**

- 3/4" Drive Deep Length
- 4 Points
- Metric Size



M7 NO.	D1	D2	L	g
	mm	mm	mm	
MA641M17	17	37	44	52
MA641M19	19	39	44	52
MA641M20	20	41	44	52
MA641M21	21	42	44	52

## MB65008M1

**Deep Impact Socket Set**  
 8pcs 3/4" Drive Metric Size

Contents : 21mm, 23mm, 24mm, 27mm  
 30mm, 32mm, 36mm, 41mm



## MB46008R

**Star Bit Socket Set**  
 8pcs 1/2" Drive

Contents : T30, T40, T45, T47,  
 T50, T55, T60, T70



## MB46010R

**Star Bit Socket Set**  
 10pcs 1/2" Drive

Contents : T20, T25, T27, T30, T40, T45,  
 T50, T55, T60, T70



# AIR IMPACT WRENCH



## NC-4255Q NC-4265Q

1/2" DRIVE Twin Hammer Type  
Air inlet : 1/4"

NC-4265 is equipped with 2" extended anvil



## NC-4255QP

WITH PROTECTIVE COVER INSIDE



## NC-4255QH EZ GREASE ANVIL



## NC-4255PVC PROTECTIVE COVER



The NC-4255PVC Protective Boot can apply on NC-4255Q & NC-6255Q



## NC-3610Q

3/8" DRIVE Jumbo Hammer Type  
Air inlet : 1/4"



## NC-3210

3/8" DRIVE Twin Hammer Type  
Air inlet : 1/4"



## NC-3831

3/8" DRIVE Twin Dog Type  
Air inlet : 1/4"



	Square Drive Inch	Bolt Capacity Inch (mm)	Torque Range FT-LB (Nm)	Max Torque FT-LB Nm	Free Speed R.P.M	Avg. Air Consumption CFM (L/min)	Air Pressure PSI (bar)	Overall Length Inch (mm)	Net Weight LBS kg	Air Hose Inch	Sound Pressure dBA	Vibration Level m/s <sup>2</sup>
NC-4255Q	1/2"	1"(25)	200-800(271-1085)	1200 1627	8500	4.8(136)	90(6.3)	7-1/32"(179)	3.7 1.70	3/8"	85.0	4.7
NC-4265Q	1/2"	1"(25)	200-800(271-1085)	1200 1627	8500	4.8(136)	90(6.3)	9-1/32"(230.5)	3.85 1.75	3/8"	85.0	4.7
NC-4255QP	1/2"	1"(25)	200-800(271-1085)	1200 1627	8500	4.8(136)	90(6.3)	7-1/32"(179)	4.0 1.80	3/8"	85.0	4.7
NC-4255QH	1/2"	1"(25)	200-800(271-1085)	1200 1627	8500	4.8(136)	90(6.3)	7-1/32"(179)	3.7 1.70	3/8"	85.0	4.7
NC-3610Q	3/8"	1/2"(13)	100-300(136-407)	350 474	8000	4.4(124)	90 (6.3)	4-9/16" (115.5)	3.3 1.50	3/8"	85.0	2.8
NC-3210	3/8"	1/2"(13)	100-300(136-407)	350 474	10000	4.0(113)	90 (6.3)	5-5/8" (142)	3.3 1.50	3/8"	92.1	3.6
NC-3831	3/8"	15/32"(M12)	80-120(108-162)	180 244	8000	10(283)	90 (6.3)	7-9/32" (185)	2.9 1.34	3/8"	93.0	4.9





## NC-398

**3/8" DRIVE** Jumbo Hammer Type  
Air inlet : 1/4"



## RA-111

**3/8" DRIVE** Twin Hammer Type  
Air inlet : 1/4"



## NC-3812

**3/8" DRIVE** Twin Dog Type  
Air inlet : 1/4"



## NC-3410

**3/8" DRIVE** Rocking Dog Type  
Air inlet : 1/4"



## NC-3810

**3/8" DRIVE** Twin Dog Type  
Air inlet : 1/4"



## NC-4811

**1/2" DRIVE** Twin Dog Type  
Air inlet : 1/4"



## NC-4258

**1/2" DRIVE** Twin Hammer Type  
Air inlet : 1/4"



## NC-4130

**1/2" DRIVE** Pin clutch Type  
Air inlet : 1/4"



**1.2 m/s<sup>2</sup>**  
**VIBRATION LOW**

	Square Drive	Bolt Capacity	Torque Range	Max Torque		Free Speed	Avg. Air Consumption	Air Pressure	Overall Length	Net Weight		Air Hose	Sound Pressure	Vibration Level
	Inch	Inch (mm)	FT-LB (Nm)	FT-LB	Nm	R.P.M	CFM (L/min)	PSI (bar)	Inch (mm)	LBS	kg	Inch	dBA	m/s <sup>2</sup>
NC-398	3/8"	9/16" (14)	50-200(68-271)	300	407	6500	4.2(119)	90 (6.3)	9-3/4"(247)	3.0	1.37	3/8"	85.0	2.0
RA-111	3/8"	5/16" (8)	3.7-36.9(5-50)	50	68	8500	8.5(255)	90 (6.3)	8-1/4"(208)	2.2	1.0	3/8"	96.7	4.9
NC-3812	3/8"	M10~M12	60-120(81-162)	180	244	8000	10(283)	90 (6.3)	7-31/64" (190)	2.3	1.06	3/8"	97.0	5.1
NC-3410	3/8"	3/8"(10)	5-50(7-68)	75	102	10000	2.5(71)	90 (6.3)	6-1/4" (159)	1.7	0.80	3/8"	92.1	3.6
NC-3810	3/8"	3/8"(10)	5-50(7-67)	75	101	11000	2.3(65)	90 (6.3)	5-15/32" (139)	1.1	0.50	3/8"	91.0	3.6
NC-4811	1/2"	9/16"(14)	118-140 (160-189)	210	285	5500	8.5(240)	90(6.3)	10-9/32" (260)	3.7	1.70	3/8"	85.0	5.3
NC-4258	1/2"	5/8"(16)	150-300(203-407)	400	542	7000	4.2(119)	90(6.3)	7-1/4"(185)	5.6	2.50	3/8"	93.0	4.4
NC-4130	1/2"	5/8"(16)	180-400(244-542)	600	813	9000	4.5(127)	90(6.3)	5-9/16"(142)	3.55	1.61	3/8"	93.0	1.2

# AIR IMPACT WRENCH

AIR IMPACT WRENCH



## NC-4256 NC-4256Q NC-4256Q-2

1/2" DRIVE Twin Hammer Type  
Air inlet : 1/4"



## NC-4233Q NC-4233QH (EZ GREASE ANVIL)

1/2" DRIVE Twin Hammer Type  
Air inlet : 1/4"

PATENT  
GREASE HOLE

FOR EZ GREASE  
VERSION ONLY  
(NC-4233QH)



## NC-4650 NC-4650H (EZ GREASE ANVIL)

1/2" DRIVE Jumbo Hammer Type  
Air inlet : 1/4"

PATENT  
GREASE HOLE

FOR EZ GREASE  
VERSION ONLY



## NC-4610 NC-4610Q

1/2" DRIVE Twin Hammer Type  
Air inlet : 1/4"



## NC-4236 NC-4236Q

1/2" DRIVE Twin Hammer Type  
Air inlet : 1/4"



## NC-4630 NC-4630Q

1/2" DRIVE Jumbo Hammer Type  
Air inlet : 1/4"



## NC-4233TL

1/2" DRIVE Twin Hammer Type  
Air inlet : 1/4"



- Forward operation torque is limited 50 ~ 80 Nm for vehicle tire service.
- 6 rotor-blades makes efficient starting torque.



## NC-498

1/2" DRIVE Jumbo Hammer Type  
Air inlet : 1/4"



## NC-4232Q

1/2" DRIVE Twin Hammer Type  
Air inlet : 1/4"



## NC-4210

1/2" DRIVE Twin Hammer Type  
Air inlet : 1/4"



## NC-4230 NC-4230Q NC-4240

1/2" DRIVE Twin Hammer Type  
Air inlet : 1/4"

- NC-4240 is equipped with 2" extended anvil







## NC-4600-KIT

3/8" & 1/2" DRIVE Jumbo Hammer Type  
Air inlet : 1/4"

- NC-4600 is equipped with 3/8" & 1/2" anvil



## NC-4600-14Kit

3/8" & 1/2" DRIVE Jumbo Hammer Type  
Air inlet : 1/4"

- NC-4600 is equipped with 3/8" & 1/2" anvil

### Contents :

- +1 pc Air Impact Wrench
- +2 pc Square Head Drive : 3/8" & 1/2"
- +1 pc Lubricating Oil
- +1 pc Release Pin
- +4 pc Impact Socket : 13-17-19-21 mm
- +1 pc Impact Extension Bar : 14mm
- +2 pc Bit Holder : 8 mm & 10 mm
- +1 pc 12 mm Hex Bit
- +1 pc T60 Torx



Square Drive	Bolt Capacity	Torque Range	Max Torque	Free Speed	Avg. Air Consumption	Air Pressure	Overall Length	Net Weight	Air Hose	Sound Pressure	Vibration Level			
Inch	Inch (mm)	FT-LB (Nm)	FT-LB Nm	R.P.M	CFM (L/min)	PSI (bar)	Inch (mm)	LBS kg	Inch	dBA	m/s <sup>2</sup>			
NC-4256	1/2"	1"(25)	200-900(271-1220)	1100	1491	9000	5.1(144)	90(6.3)	5-9/16"(141)	4.0	1.80	3/8"	95.0	2.8
NC-4256Q	1/2"	1"(25)	200-900(271-1220)	1000	1356	7000	5.1(144)	90(6.3)	5-9/16"(141)	4.0	1.80	3/8"	85.0	2.8
NC-4256Q-2	1/2"	1"(25)	200-900(271-1220)	1000	1356	7000	5.1(144)	90(6.3)	7-9/16"(191)	4.2	1.90	3/8"	85.0	2.8
NC-4233Q	1/2"	3/4"(19)	200-500(271-678)	850	1152	9000	4.6(132)	90(6.3)	7-1/2"(190)	4.6	2.10	3/8"	85.0	4.4
NC-4233QH	1/2"	3/4"(19)	200-500(271-678)	850	1152	9000	4.6(132)	90(6.3)	7-1/2"(190)	4.6	2.10	3/8"	85.0	4.4
NC-4650	1/2"	5/8"(16)	180-400(244-542)	650	900	9000	4.69(132.8)	90(6.3)	4-1/16"(104)	3.3	1.40	3/8"	95.0	2.4
NC-4650H	1/2"	5/8"(16)	180-400(244-542)	650	900	9000	4.69(132.8)	90(6.3)	4-1/16"(104)	3.3	1.40	3/8"	95.0	2.4
NC-4610	1/2"	5/8"(16)	200-350(271-475)	450	610	9000	4.4(124)	90(6.3)	4-9/16"(115.5)	3.5	1.60	3/8"	93.0	2.8
NC-4610Q	1/2"	5/8"(16)	200-350(271-475)	400	542	9000	4.4(124)	90(6.3)	4-9/16"(115.5)	3.5	1.60	3/8"	85.0	2.8
NC-4236	1/2"	1"(25)	200-700(271-949)	100	1355	7500	5.5(155)	90(6.3)	6-45/64"(171)	5.7	2.60	3/8"	87.0	4.5
NC-4236Q	1/2"	1"(25)	200-700(271-949)	1000	1355	7500	5.5(155)	90(6.3)	6-45/64"(171)	5.7	2.60	3/8"	83.0	4.5
NC-4630	1/2"	5/8"(16)	100-400(136-542)	450	610	9000	4.4(124)	90(6.3)	3-27/32"(97)	3.3	1.50	3/8"	96.0	2.8
NC-4630Q	1/2"	5/8"(16)	200-350(271-475)	450	610	9000	4.4(124)	90(6.3)	3-27/32"(97)	3.3	1.50	3/8"	85.0	2.8
NC-4233TL	1/2"	3/4"(19)	37-59(50-80)	850	1152	2800	4.6(132)	90(6.3)	7-1/2"(190)	4.6	2.10	3/8"	85.0	4.4
NC-498	1/2"	5/8"(16)	80-300(108-407)	400	542	6500	4.2(119)	90(6.3)	9-3/4"(247)	3.0	1.37	3/8"	85.0	2.0
NC-4232Q	1/2"	5/8"(16)	100-400(136-542)	550	746	10000	4.0(113)	90(6.3)	4-3/4"(120)	3.0	1.38	3/8"	83	3.7
NC-4210	1/2"	5/8"(16)	150-350(203-475)	400	542	10000	4.2(119)	90(6.3)	5-5/8"(142)	3.5	1.60	3/8"	90.6	2.8
NC-4230	1/2"	3/4"(19)	180-500(244-678)	700	949	7500	4.5(127)	90(6.3)	6-15/32"(164)	5.5	2.50	3/8"	87	4.5
NC-4230Q	1/2"	3/4"(19)	180-500(244-678)	650	881	6500	4.5(127)	90(6.3)	6-15/32"(164)	5.5	2.50	3/8"	85	4.5
NC-4240	1/2"	3/4"(19)	180-500(244-678)	700	949	7500	4.5(127)	90(6.3)	8-15/32"(215)	5.7	2.60	3/8"	87	4.5
NC-4600	1/2"	5/8"(16)	180-500(244-678)	600	813	9000	4.2(119)	90(6.3)	4"(99)	2.97	1.35	3/8"	96	3.7

# AIR IMPACT WRENCH

AIR IMPACT WRENCH



## NC-4210N

1/2" DRIVE Twin Hammer Type  
Air inlet : 1/4"

- stubby impact sockets, 6 points:5pcs 13,17,19,22,24 mm



## NC-4610N

1/2" DRIVE Twin Hammer Type  
Air inlet : 1/4"

- stubby impact sockets, 6 points:5pcs 13,17,19,22,24 mm



## NC-6201

3/4" DRIVE Twin Hammer Type  
Air inlet : 3/8"

- NC-6201 is equipped with 3/4" anvil



## NC-6256Q

3/4" DRIVE Twin Hammer Type  
Air inlet : 1/4"

- NC-6256Q is equipped with 3/4" anvil

1627 N.m  
**SUPER MINI**



## NC-6215 / NC-6225

3/4" DRIVE New Twin Hammer Type  
Air inlet : 3/8"

- NC-6225 is equipped with 6" extended anvil



## NC-6217

3/4" DRIVE Twin Hammer Type  
Air inlet : 3/8"



## NC-6218

3/4" DRIVE Twin Hammer Type  
Air inlet : 3/8"



	Square Drive	Bolt Capacity	Torque Range	Max Torque	Free Speed	Avg. Air Consumption	Air Pressure	Overall Length	Net Weight	Air Hose	Sound Pressure	Vibration Level
	Inch	Inch (mm)	FT-LB (Nm)	FT-LB Nm	R.P.M	CFM (L/min)	PSI (bar)	Inch (mm)	LBS kg	Inch	dBA	m/s <sup>2</sup>
NC-4210N	1/2"	5/8"(16)	150-350(203-475)	400 542	10000	4.2(119)	90(6.3)	5-5/8"(142)	3.5 1.60	3/8"	90.6	2.8
NC-4610N	1/2"	5/8"(16)	200-350(271-475)	450 610	9000	4.4(124)	90(6.3)	4-9/16"(115.5)	3.5 1.60	3/8"	93.0	2.8
NC-6201	3/4"	1-3/16"(30)	200-1200(271-1627)	1450 1966	5700	6.4(181)	90(6.3)	8-3/4"(222)	8.14 3.7	1/2"	88.0	5.9
NC-6256Q	3/4"	7/8"(23)	150-900(203-1220)	1200 1627	7000	5.1(144)	90(6.3)	5-11/16"(145)	4.18 1.9	3/8"	85.0	2.8
NC-6215	3/4"	1"(25)	180-600(244-810)	900 1220	6500	7.0(198)	90(6.3)	9-7/32"(234)	10.0 4.50	1/2"	91.5	10.8
NC-6225	3/4"	1"(25)	180-600(244-810)	900 1220	6500	7.0(182)	90(6.3)	13-3/4"(350)	10.8 4.90	1/2"	91.5	10.8
NC-6217	3/4"	1-1/4"(30)	200-1300(271-1762)	1400 1898	4800	5.4(153)	90(6.3)	8-15/32" (215)	11.0 5.00	1/2"	92.0	6.1
NC-6218	3/4"	1-1/16"(27)	200-1400(271-1898)	1500 2034	6000	6.3(182)	90(6.3)	12-9/16"(320)	12.5 5.70	1/2"	106.0	3.3



## NC-6266H (EZ GREASE ANVIL)

3/4" DRIVE Twin Hammer Type  
Air inlet : 3/8"



PATENT  
GREASE  
HOLE  
FOR EZ GREASE  
VERSION ONLY



## NC-6266 NC-6266-6

3/4" DRIVE Twin Hammer Type  
Air inlet : 3/8"



- NC-6266-6 is equipped with 6" extended anvil
- The NC-4255PVC Protective cover can apply on NC-6255



## NC-6255Q NC-6255QH

3/4" DRIVE Twin Hammer Type  
Air inlet : 3/8"



PATENT  
GREASE  
HOLE  
FOR EZ GREASE  
VERSION ONLY



## NC-6113 / NC-6123

3/4" DRIVE Pin Clutch Type  
Air inlet : 3/8"



- NC-6123 is equipped with 6" extended anvil



## NC-6210 / NC-6210Q NC-6220

3/4" DRIVE Twin Hammer Type  
Air inlet : 3/8"



- NC-6220 is equipped with 6" extended anvil



## NC-6236 NC-6236Q

3/4" DRIVE Twin Hammer Type  
Air inlet : 3/8"



Square Drive	Bolt Capacity	Torque Range	Max Torque	Free Speed	Avg. Air Consumption	Air Pressure	Overall Length	Net Weight	Air Hose	Sound Pressure	Vibration Level
Inch	Inch (mm)	FT-LB (Nm)	FT-LB Nm	R.P.M	CFM (L/min)	PSI (bar)	Inch (mm)	LBS kg	Inch	dBA	m/s <sup>2</sup>
NC-6266H	3/4"	1-1/4"(30)	200-1300(271-1760)	1500 2034	6000	5.9(169)	90(6.3)	8-1/16"(205)	6.5 3	1/2"	88.0 5.9
NC-6266	3/4"	1-1/4"(30)	200-1300(271-1760)	1500 2034	6000	5.9(169)	90(6.3)	8-1/16"(205)	6.5 2.95	1/2"	88.0 5.9
NC-6266-6	3/4"	1-1/4"(30)	200-1300(271-1760)	1500 2034	6000	5.9(169)	90(6.3)	14-1/16"(355)	7.9 3.60	1/2"	88.0 5.9
NC-6255Q	3/4"	1"(25)	200-1100(271-1491)	1400 1898	8500	4.8(136)	90(6.3)	7-13/16"(198)	4.2 1.90	3/8"	85.0 4.7
NC-6255QH	3/4"	1"(25)	200-1100(271-1491)	1400 1898	8500	4.8(136)	90(6.3)	7-13/16"(198)	4.2 1.90	3/8"	85.0 4.7
NC-6113	3/4"	1"(25)	150-600(203-814)	850 1153	4500	7.0(198)	90(6.3)	10"(252)	10.1 4.6	1/2"	94.3 7.2
NC-6123	3/4"	1"(25)	150-600(203-814)	850 1163	4500	7.0(198)	90(6.3)	14-3/16"(360)	11.6 5.30	1/2"	94.3 7.2
NC-6210	3/4"	3/4"(19)	180-600(244-810)	750 1017	7500	4.5(127)	90(6.3)	6-45/64"(170)	5.6 2.55	3/8"	87.0 4.5
NC-6210Q	3/4"	3/4"(19)	180-600(244-810)	700 949	6500	4.5(127)	90(6.3)	6-45/64"(170)	5.6 2.55	3/8"	85.0 4.5
NC-6220	3/4"	3/4"(19)	180-600(244-810)	750 1017	7500	4.5(127)	90(6.3)	12-23/32"(323)	6.7 3.08	3/8"	87.0 4.5
NC-6236	3/4"	1"(25)	200-900(271-1220)	1200 1627	7500	5.5(155)	90(6.3)	6-45/64"(171)	5.9 2.68	3/8"	87.0 4.5
NC-6236Q	3/4"	1"(25)	200-900(271-1220)	1200 1627	7500	5.5(155)	90(6.3)	6-45/64"(171)	5.9 2.68	3/8"	83.0 4.5



# AIR IMPACT WRENCH



## NC-6216 / NC-6226

3/4" DRIVE Twin Hammer Type  
Air inlet : 3/8"

● NC-6226 is equipped with 6" extended anvil

● Composite material

**NC-6216PVC**  
Protective cover



## NC-8266P / NC-8266P-6

1" DRIVE Twin Hammer Type  
Air inlet : 3/8"

NC-8266P-6 is equipped with 6" extended anvil



## NC-8212

1" DRIVE New Twin Hammer Type  
Air inlet : 3/8"



## NC-8217

1" DRIVE Twin Hammer Type  
Air inlet : 3/8"



## NC-8219

1" DRIVE New Twin Hammer Type  
Air inlet : 1/2"

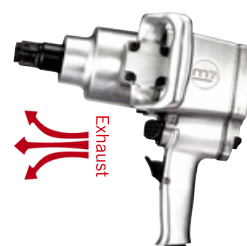

## NC-8237 NC-8237-6

1" DRIVE Twin Hammer Type  
Air inlet : 3/8"

NC-8237-6 is equipped with 6" extended anvil



## NC-8343 NC-8343-8

1" DRIVE Pin Less Type  
Air inlet : 1/2"

NC-8343-8 is equipped with 8" extended anvil





## NC-8211 NC-8221

**1" DRIVE** Twin Hammer Type  
Air inlet : 1/2"



NC-8221 is equipped with 6" extended anvil



## NC-8232

**1" DRIVE** New twin Hammer Type  
Air inlet : 1/2"

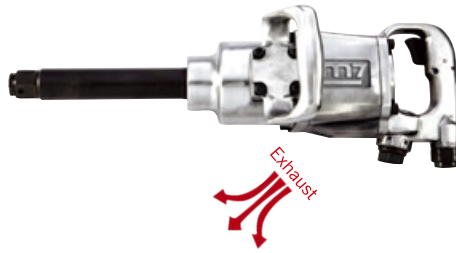

## NC-8311 NC-8351

**1" DRIVE** Pin Less Type  
Air inlet : 1/2"

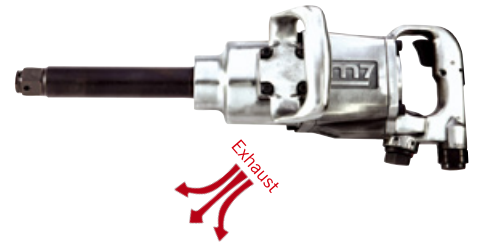

NC-8351 is equipped with 6" extended anvil

Model	Bolt Capacity		FT-LB (Nm)	FT-LB Nm	R.P.M	Avg. Air Consumption		Air Pressure		Inch (mm)	LBS kg	Inch	Sound Pressure dBA	Vibration Level m/s <sup>2</sup>
	Inch	Inch (mm)				CFM (L/min)	PSI (bar)							
NC-6216	3/4"	1-1/16"(27)	200-1000(271-1356)	1200 1627	6000	6.0(170)	90(6.3)	9-1/4"(235)	9.0 4.10	1/2"	91.2	5.0		
NC-6226	3/4"	1-1/16"(27)	200-1000(271-1356)	1200 1627	6000	6.0(170)	90(6.3)	13-3/4"(350)	9.9 4.50	1/2"	91.2	5.0		
NC-6213	3/4"	1-1/16"(27)	200-1000(271-1356)	1200 1627	6000	6.9(195)	90(6.3)	9-7/16"(239)	8.5 3.88	1/2"	92.0	5.0		
NC-8212	1"	1-1/16"(27)	200-1000(271-1356)	1300 1762	6000	6.0(170)	90(6.3)	9-1/4"(235)	9.6 4.40	1/2"	91.2	5.0		
NC-8217	1"	1-1/4"(30)	200-1300(271-1762)	1500 2034	4800	5.4(153)	90(6.3)	8-3/4"(222)	11.0 5.00	1/2"	92.0	6.1		
NC-8219	1"	1-7/16"(36)	200-1600(271-2170)	1800 2441	4000	11(311)	90(6.3)	12-13/32"(315)	21.6 9.84	1/2"	103.4	16.7		
NC-8237	1"	1-3/8"(33)	200-1500(271-2034)	1800 2441	4500	5.4(153)	90(6.3)	8-3/4"(222)	12.8 5.70	1/2"	92.0	6.1		
NC-8237-6	1"	1-3/8"(33)	200-1500(271-2034)	1800 2441	4500	5.4(153)	90(6.3)	15-9/16"(395)	14.3 6.50	1/2"	92.0	6.1		
NC-8343	1"	1-3/8"(33)	200-1600(271-2170)	1800 2441	3900	11.5(325)	90(6.3)	15"(381)	27.7 12.5	1/2"	103	6.3		
NC-8343-8	1"	1-3/8"(33)	200-1600(271-2170)	1800 2441	3900	11.5(325)	90(6.3)	23"(590)	30.6 13.9	1/2"	103	6.3		
NC-8266P	1"	1-3/8"(35)	200-2000(271-2711)	2300 3118	4500	9(255)	90(6.3)	10"(256)	13 5.90	1/2"	92.0	6.1		
NC-8266P-6	1"	1-3/8"(35)	200-2000(271-2711)	2300 3118	4500	9(255)	90(6.3)	10"(256)	13.86 6.30	1/2"	92.0	6.1		
NC-8211	1"	1-3/8"(33)	200-1600(271-2170)	1800 2441	5000	10.0(284)	90(6.3)	14-9/16"(370)	22.2 10.1	1/2"	100	10.0		
NC-8221	1"	1-3/8"(33)	200-1600(271-2170)	1800 2441	5000	10.0(284)	90(6.3)	20-7/8"(530)	25.2 11.5	1/2"	100	10.0		
NC-8232	1"	1-7/16"(36)	200-1600(271-2170)	1800 2441	4000	11.0(311)	90(6.3)	20-13/32"(518)	24.8 11.3	1/2"	102	11.5		
NC-8311	1"	1-3/8"(33)	200-1600(271-2170)	1800 2441	4000	11.5(325)	90(6.3)	15"(380)	24.0 10.9	1/2"	101	7.3		
NC-8351	1"	1-3/8"(33)	200-1600(271-2170)	1800 2441	4000	11.5(325)	90(6.3)	20"(510)	27.6 12.5	1/2"	101	7.3		

# AIR IMPACT WRENCH



## NC-8266S NC-8266S-6 NC-8266S-8

1" DRIVE Twin Hammer Type  
Air inlet : 1/2"

- NC-8266S-6 is equipped with 6" extended anvil
- NC-8266S-8 is equipped with 8" extended anvil



## NC-8382 NC-8382-8

1" DRIVE Pin Less Type  
Air inlet : 1/2"

NC-8382-8 is equipped with 8" extended anvil



## NC-8252 NC-8262

1" DRIVE Twin Hammer Type  
Air inlet : 1/2"

NC-8262 is equipped with 6" extended anvil



## NC-8216 NC-8226 NC-8226Q

1" DRIVE Twin Hammer Type  
Air inlet : 1/2"

● NC-8226 is equipped with 6" extended anvil



NC-8226Q



## NC-8242 NC-8242-8

1" DRIVE Twin Hammer Type  
Air inlet : 1/2"

NC-8242-8 is equipped with 8" extended anvil



## NC-8332X NC-8332X-6

1" DRIVE Pin Less Type  
Air inlet : 1/2"

NC-8332X-6 is equipped with 6" extended anvil







**NC-8322**  
**NC-8342**

**1" DRIVE** Pin Less Type  
Air inlet : 1/2"



**NC-8362**  
**NC-8372**

**1" DRIVE** Pin Less Type  
Air inlet : 1/2"



**NC-9223**  
**NC-9243**

**1-1/2" DRIVE** New Twin Hammer Type  
Air inlet : 1/2"

NC-8342 is equipped with 8" extended anvil

NC-8372 is equipped with 6" extended anvil

NC-9243 is equipped with 8" extended anvil



	Square Drive	Bolt Capacity	Torque Range	Max Torque		Free Speed	Avg. Air Consumption	Air Pressure	Overall Length	Net Weight		Air Hose	Sound Pressure	Vibration Level
	Inch	Inch (mm)	FT-LB (Nm)	FT-LB	Nm	R.P.M	CFM (L/min)	PSI (bar)	Inch (mm)	LBS	kg	Inch	dBA	m/s <sup>2</sup>
NC-8266S	1"	1-3/8"(35)	200-1800(272-2448)	2300	3118	4500	7.5(212)	90(6.3)	16-7/8"(430)	13.2	6.0	1/2"	92	6.1
NC-8266S-6	1"	1-3/8"(35)	200-1800(272-2448)	2300	3118	4500	7.5(212)	90(6.3)	22-3/4"(580)	15.84	7.3	1/2"	92	6.1
NC-8266S-8	1"	1-3/8"(35)	200-1800(272-2448)	2300	3118	4500	7.5(212)	90(6.3)	24-3/4"(630)	16.28	7.4	1/2"	92	6.1
NC-8216	1"	1-3/8"(33)	200-1600(271-2170)	1800	2441	6000	9.0(254)	90(6.3)	13-1/2"(343)	15.5	7.0	1/2"	102	9.3
NC-8226	1"	1-3/8"(33)	200-1600(271-2170)	1800	2441	6000	9.0(254)	90(6.3)	19-3/16"(487)	18.4	8.4	1/2"	102	9.3
NC-8226Q	1"	1-3/8"(33)	200-1600(271-2170)	1800	2441	6000	9.0(254)	90(6.3)	19-3/16"(487)	18.4	8.4	1/2"	90	9.3
NC-8382	1"	1-9/16"(40)	200-2000(271-2710)	2500	3390	5000	15.9(450)	90(6.3)	14-17/32"(370)	22.0	11.0	1/2"	100.0	6.4
NC-8382-8	1"	1-9/16"(40)	200-2000(271-2710)	2500	3390	5000	15.9(450)	90(6.3)	22-15/32"(570)	27.5	12.5	1/2"	100.0	6.4
NC-8242	1"	1-9/16"(40)	200-2000(271-2710)	2500	3390	5000	15.9(450)	90(6.3)	14-17/32"(370)	23.1	10.5	1/2"	100.0	6.4
NC-8242-8	1"	1-9/16"(40)	200-2000(271-2710)	2500	3390	5000	15.9(450)	90(6.3)	22-15/32"(570)	26.2	11.9	1/2"	100.0	6.4
NC-8252	1"	1-7/16"(36)	200-2000(271-2170)	2400	3250	4000	10.0(284)	90(6.3)	15-3/8"(390)	26.6	12.1	1/2"	100.0	10.0
NC-8262	1"	1-7/16"(36)	200-2000(271-2170)	2400	3250	4000	10.0(284)	90(6.3)	22"(560)	29.7	13.5	1/2"	100.0	10.0
NC-8332X	1"	1-3/8"(25)	200-2000(271-2710)	2500	3390	4000	8.0(226.5)	90(6.3)	14-11/16"(372.6)	20.7	9.4	3/8"	103.8	8.22
NC-8332X-6	1"	1-3/8"(25)	200-2000(271-2710)	2500	3390	4000	8.0(226.5)	90(6.3)	14-11/16"(372.6)	23.3	9.4	3/8"	103.8	8.22
NC-8322	1"	1-7/16"(36)	200-2000(271-2170)	2500	3390	3300	11.0(311)	90(6.3)	17-5/16"(440)	34.2	15.5	1/2"	93.9	8.8
NC-8342	1"	1-7/16"(36)	200-2000(271-2170)	2500	3390	3300	11.0(311)	90(6.3)	24-3/8"(619)	38.0	17.3	1/2"	93.9	8.8
NC-8362	1"	1-7/16"(36)	200-2000(271-2170)	2500	3390	3700	11.0(284)	90(6.3)	17-7/8"(455)	35.2	16.0	1/2"	93.9	8.8
NC-8372	1"	1-7/16"(36)	200-2000(271-2170)	2500	3390	3700	11.0(284)	90(6.3)	24-7/32"(615)	38.7	17.6	1/2"	93.9	8.8
NC-9223	1-1/2"	2"(50)	200-3000(271-4065)	3500	4746	3000	16.0(453)	90(6.3)	17-3/4"(450)	43.2	19.7	3/4"	104.5	8.8
NC-9243	1-1/2"	2"(50)	200-3000(271-4065)	3500	4746	3000	16.0(453)	90(6.3)	24-1/4"(616)	50.2	22.8	3/4"	104.5	8.8

# AIR IMPACT WRENCH

AIR IMPACT WRENCH

## NC-4232Q KIT

1/2" DRIVE

### CONTENTS 11 PCS

- 1pc - 1/2" Air Impact Wrench
- 7pcs - Impact sockets, MA411M13, 17, 19, 21, 22, 24, 27
- 1pc - 5" Extension bar
- 1pc - Mini Lubricator SW-12
- 1pc - 1/4" plug



## NC-4233Q KIT

1/2" DRIVE

### CONTENTS 11 PCS

- 1pc - 1/2" Air Impact Wrench
- 7pcs - Impact sockets, MA411M13, 17, 19, 21, 22, 24, 27
- 1pc - 5" Extension bar
- 1pc - Mini Lubricator SW-12
- 1pc - 1/4" plug



## NC-4255Q KIT

1/2" DRIVE

### CONTENTS 11 PCS

- 1pc - 1/2" Air Impact Wrench
- 7pcs - Impact sockets, MA411M13, 17, 19, 21, 22, 24, 27
- 1pc - 5" Extension bar
- 1pc - Mini Lubricator SW-12
- 1pc - 1/4" plug



## NC-4650 KIT

1/2" DRIVE

### CONTENTS 11 PCS

- 1pc - 1/2" Air Impact Wrench
- 7pcs - Impact sockets, MA411M13, 17, 19, 21, 22, 24, 27
- 1pc - 5" Extension bar
- 1pc - Mini Lubricator SW-12
- 1pc - 1/4" plug



## NC-6236 KIT

3/4" DRIVE

### CONTENTS 11 PCS

- 1pc - 3/4" Air Impact Wrench
- 7pcs - Impact sockets, MA611M24, 27, 30, 32, 33, 34, 36
- 1pc - 7" Extension bar
- 1pc - Mini Lubricator SW-12
- 1pc - 1/4" plug



## NC-6255Q KIT

3/4" DRIVE

### CONTENTS 11 PCS

- 1pc - 3/4" Air Impact Wrench
- 7pcs - Impact sockets, MA611M24, 27, 30, 32, 33, 34, 36
- 1pc - 7" Extension bar
- 1pc - Mini Lubricator SW-12
- 1pc - 1/4" plug



## NC-0615KIT

3/4" DRIVE

### CONTENTS 15 PCS

- 1pc-3/4" Air Impact Wrench
- 8pcs-Impact sockets, 6 points, standard length 26, 27, 29, 30, 32, 35, 36, 38mm
- 1pc-Extension bar 7"
- 1pc-Universal Joint
- 2pcs-Allen Key : 4mm, 5mm
- 1pc-Mini Oiler 1/4"-6113,6215, 3/8"-6216
- 1pc-1/4" plug - 6113,6215, 3/8" plug - 6216
- 1pc-O-Ring & Pin



## NC-0415 KIT

1/2" DRIVE

### CONTENTS 15 PCS

- 1pc - 1/2" Air Impact Wrench
- 10pcs - Impact sockets, 6 points, standard length 9, 10, 11, 13, 14, 17, 19, 22, 24, 27mm
- 1pc - Extension bar 5"
- 1pc - Allen Key : 4mm
- 1pc - Mini Oiler 1/4" female x 1/4" male
- 1pc - 1/4" plug



NC-0615M0  
NC-6113



NC-0615M1  
NC-6216



NC-0615M2  
NC-6215



NC-0415M3  
NC-4258



NC-0415M4  
NC-4230



NC-0415M5  
NC-4233



NC-0415M9  
NC-4256



# NC-4255Q-41KIT NC-4255Q-41KITA05

- TORQUE WRENCH 1 PC 42-210 NM(TE-442210N)
- THIN WALL IMPACT SOCKET 3 PCS 17.19.21mm
- IMPACT DEEP SOCKET 13 PCS 10.11.12.13.14.15.16.17.18.19.21.22.24 mm
- IMPACT SOCKET 16 PCS 10.11.12.13.14.15.16.17.18.19.21.22.24.27.30.32 mm
- AIR IMPACT WRENCH 1 PC MAX TORQUE: 1627 NM/1200 FT-LB (NC-4255Q)
- EXTENSION BAR 2 PCS 75 mm.125 mm (ME421-05 /ME421-03)
- UNIVERSAL JOINT 1 PC 1/2" DRIVE (ME4711)
- AIR BLOW GUN 1 PC 250 mm(JC-310)
- MINI LUBRICATOR 1 PC 1/4"DRIVE(SW-12)
- AIR ADAPTER 2 PCS 1/4" PLUG



NC-4255Q-41KITA05



Can be customized



## NEW PRODUCT



### NC-3231Q

3/8" DRIVE Twin Hammer Type  
Air inlet : 1/4"



### NC-4117

1/2" DRIVE Pin clutch Type  
Air inlet : 1/4"



### NC-4277Q

1/2" DRIVE Twin Hammer Type  
Air inlet : 1/4"



### NC-4299Q

1/2" DRIVE Twin Hammer Type  
Air inlet : 1/4"



Square Drive	Bolt Capacity	Torque Range	Max Torque		Free Speed	Avg. Air Consumption	Air Pressure	Overall Length	Net Weight		Air Hose	Sound Pressure	Vibration Level
			FT-LB	Nm					LBS	kg			
Inch	Inch (mm)	FT-LB (Nm)	FT-LB	Nm	R.P.M	CFM (L/min)	PSI (bar)	Inch (mm)	lb	kg	Inch	dBA	m/s <sup>2</sup>
NC-3231Q	3/8"	1/2"(13)	200-350(271-475)	450 610	8000	4.2(129)	90(6.3)	6-5/16 "(160)	2.8	1.3	3/8"	83.0	3.0
NC-4117	1/2"	3/4"(18)	200-550(271-746)	700 949	7000	5.4(153)	90(6.3)	8" (205)	4.3	1.95	3/8"	90.0	2.5
NC-4277Q	1/2"	1"(25)	200-800(271-1088)	1150 1564	7000	4.8(136)	90(6.3)	6" (155)	4.4	2	3/8"	85.0	4.5
NC-4299Q	1/2"	3/4"(19)	150-500(204-680)	800 1088	8500	4.0(113)	90(6.3)	7-1/2" (194)	4.6	2.1	3/8"	85.0	3.2



# AIR RATCHET WRENCH

AIR RATCHET WRENCH



## NE-383 / NE-483

3/8" & 1/2" DRIVE Air inlet : 1/4"



**Stylized grip**



## NE-3305 / NE-4305

3/8" & 1/2" DRIVE Air inlet : 1/4"



## NE-4815

1/2" DRIVE Air inlet : 1/4"



## NE-261 / NE-361

1/4" & 3/8" DRIVE Air inlet : 1/4"



## NE-462

1/2" DRIVE Pin Clutch Type  
Air inlet : 1/4"



## NE-462T

1/2" DRIVE Pin Clutch Type  
Air inlet : 1/4"



**Stylized grip**



## NE-352

3/8" DRIVE 2 in 1 Air inlet : 1/4"



## NE-362

3/8" DRIVE 2 in 1 Air inlet : 1/4"



## NE-332 / 432

3/8" & 1/2" DRIVE Air inlet : 1/4"



## NE-321 / 421

3/8" & 1/2" DRIVE Air inlet : 1/4"



**Air Ratchet Wrench**

Air inlet : 1/4"

- NE-251R 1/4" DRIVE**
- NE-351R 3/8" DRIVE**
- NE-451R 1/2" DRIVE**



**Rubber Handle**



**NE-251 / NE-351 / NE-451**

1/4" & 3/8" & 1/2" DRIVE Air inlet : 1/4"



**NE-488**

1/2" DRIVE Air inlet : 1/4"



	Square Drive	Torque Range	Max Torque	Free Speed	Avg. Air Consumption	Air Pressure	Overall Length	Net Weight	Air Hose	Sound Pressure	Vibration Level
	Inch	FT-LB (Nm)	FT-LB Nm	R.P.M	CFM (L/min)	PSI (bar)	Inch (mm)	LBS kg	Inch	dBA	m/s <sup>2</sup>
NE-383	3/8"	15-65 (13.5-88)	100 135.6	250	5.0(141)	90 (6.3)	10-29/32"(277)	2.82 1.28	3/8"	85	2.0
NE-483	1/2"	15-65 (13.5-88)	100 135.6	250	5.0(141)	90 (6.3)	10-29/32"(277)	2.82 1.28	3/8"	85	2.0
NE-3305	3/8"	15-55 (20-75)	70 95	160	5(142)	90 (6.3)	15-3/8"(390)	3.52 1.6	3/8"	82	1.2
NE-4305	1/2"	15-55 (20-75)	70 95	160	5(142)	90 (6.3)	15-3/8"(390)	3.52 1.6	3/8"	82	1.2
NE-4815	1/2"	40-120 (54-163)	150 204	170	4.8(136)	90 (6.3)	12-1/4"(313)	3.39 1.54	3/8"	93	2.5
NE-261	1/4"	10-35(13.5-47)	37 50	230	4.0(130)	90 (6.3)	6-5/16"(160)	1.1 0.50	3/8"	88.0	3.0
NE-361	3/8"	10-35(13.5-47)	37 50	230	4.0(130)	90 (6.3)	6-6/16"(160)	1.1 0.50	3/8"	88.0	3.0
NE-462	1/2"	10-55*(13.5-74)	74 100	200	4.0(113.28)	90(6.3)	13"(330)	4.1 1.88	3/8"	84.0	2.5
NE-462T	1/2"	10-65(13.5-88)	100 135.6	200	5.0(141)	90(6.3)	13-13/32"(340)	4.0 1.83	3/8"	85.0	2.2
NE-352	3/8"	5-15(6.7-20)	22 30	350	3.0(84.96)	90 (6.3)	5"(125)	1.1 0.50	3/8"	89.0	4.4
NE-362	3/8"	10-35(13.5-47)	37 50	230	4.6(130)	90 (6.3)	6-5/16"(160)	1.1 0.50	3/8"	88.0	3.0
NE-251R	1/4"	5-15(6.7-20)	22 30	350	3.0(84.96)	90 (6.3)	5"(125)	1.1 0.50	3/8"	89.0	4.4
NE-351R	3/8"	5-15(6.7-20)	22 30	350	3.0(84.96)	90 (6.3)	5"(125)	1.1 0.50	3/8"	89.0	4.4
NE-451R	1/2"	5-20(6.7-27)	25 33.9	350	3.0(84.96)	90 (6.3)	5"(125)	1.1 0.50	3/8"	89.0	4.4
NE-251	1/4"	5-15(6.7-20)	22 30	350	3.0(84.96)	90 (6.3)	5"(125)	1.1 0.50	3/8"	89.0	4.4
NE-351	3/8"	5-15(6.7-20)	22 30	350	3.0(84.96)	90 (6.3)	5"(125)	1.1 0.50	3/8"	89.0	4.4
NE-451	1/2"	5-20(6.7-27)	25 33.9	350	3.0(84.96)	90 (6.3)	5"(125)	1.1 0.50	3/8"	89.0	4.4
NE-488	1/2"	10-40(13.5-54)	60 81	150	4.5(127.4)	90(6.3)	10-13/16"(275)	3.2 1.45	3/8"	85.0	3.9
NE-332	3/8"	10-45(13.5-61)	60 81	160	4.0(113.28)	90 (6.3)	10-3/8"(265)	3.6 1.22	3/8"	90.5	4.4
NE-432	1/2"	10-45(13.5-61)	60 81	160	4.0(113.28)	90 (6.3)	10-3/8"(265)	3.6 1.22	3/8"	89.8	5.2
NE-321	3/8"	10-35(13.5-47)	50 68	160	4.0(113.28)	90 (6.3)	10-3/8"(265)	2.3 1.04	3/8"	91.0	3.9
NE-421	1/2"	10-35(13.5-47)	50 68	160	4.0(113.28)	90 (6.3)	10-3/8"(265)	2.3 1.04	3/8"	92.8	4.6

# AIR RATCHET WRENCH



## NE-343 / 443

3/8" & 1/2" DRIVE Air inlet : 1/4"



## NE-0413 [KIT] NE-0413S [KIT]

1/2" DRIVE Air inlet : 1/4"



- 1pc Air Ratchet Wrench(NE-461)
- 8pcs 3/4" Hex Thru-hole socket : 8,9,10,12,13,14,17,19 mm (NE-0413)
- 8pcs 3/4" Hex Thru-hole socket : 5/16",3/8",7/16",1/2",9/16",5/8",11/16",3/4" (NE-0413S)
- 1pc 3" Extension Bar
- 2pcs 1/2" 3/8" Adapter
- 1pc Plug

Square Drive	Torque Range	Max Torque		Free Speed	Avg. Air Consumption	Air Pressure	Overall Length	Net Weight		Air Hose	Sound Pressure	Vibration Level	
		FT-LB	Nm					LBS	kg				
Inch	FT-LB (Nm)	FT-LB	Nm	R.P.M	CFM (L/min)	PSI (bar)	Inch (mm)			Inch	dBA	m/s <sup>2</sup>	
NE-251	1/4"	5-15(6.7-20)	22	30	350	3.0(84.96)	90 (6.3)	5"(125)	1.1	0.50	3/8"	89.0	4.4
NE-351	3/8"	5-15(6.7-20)	22	30	350	3.0(84.96)	90 (6.3)	5"(125)	1.1	0.50	3/8"	89.0	4.4
NE-451	1/2"	5-20(6.7-27)	25	33.9	350	3.0(84.96)	90 (6.3)	5"(125)	1.1	0.50	3/8"	89.0	4.4
NE-488	1/2"	10-40(13.5-54)	60	81	150	4.5(127.4)	90(6.3)	10-13/16"(275)	3.2	1.45	3/8"	85.0	3.9
NE-343	3/8"	10-55(13.5-74)	75	101.7	160	4.0(113.28)	90 (6.3)	11"(280)	2.8	1.30	3/8"	84.0	4.4
NE-443	1/2"	10-55(13.5-74)	100	135.6	160	4.0(113.28)	90 (6.3)	11"(280)	2.8	1.30	3/8"	84.0	4.4
NE-461	1/2"	10-65(13.5-88)	100	135	180	4.0(113)	90(6.3)	10-3/8"(270)	2.6	1.20	3/8"	83.0	2.3



## NE-399 / 499

3/8" & 1/2" DRIVE Jumbo Hammer Type  
Air inlet : 1/4"



## NE-499N

1/2" DRIVE Air inlet : 1/4"



- Air Angle Impact Wrench : 1pc (NE-499)
- Stubby impact sockets, 6 points :
- 9pcs 9, 10, 11, 13, 14, 17, 19, 22, 24 mm
- 1/4" plug : 1pc

Square Drive	Bolt Capacity	Torque Range	Max Torque		Free Speed	Avg. Air Consumption	Air Pressure	Overall Length	Net Weight		Air Hose	Sound Pressure	Vibration Level	
			FT-LB	Nm					LBS	kg				
Inch	Inch (mm)	FT-LB (Nm)	FT-LB	Nm	R.P.M	CFM (L/min)	PSI (bar)	Inch (mm)			Inch	dBA	m/s <sup>2</sup>	
NE-399	3/8"	9/16"(14)	50-130(68-176)	180	244	7500	2.45(69.4)	90(6.3)	13-3/8"(340)	4.0	1.83	3/8"	93.0	9.9
NE-499	1/2"	9/16"(14)	50-150(68-203)	250	339	7500	2.45(69.4)	90(6.3)	13-3/8"(340)	4.0	1.83	3/8"	93.0	9.9



★★★  **NE-0405-KIT**  
 1/2" DRIVE 5 IN 1 Air inlet : 1/4"  
 MULTIPLE TOOL KIT



- 1pc NE-9004
- 1pc QA-9120
- 1pc QA-9620
- 1pc QB-9903
- 1pc QE-2132

60FT-LB / 81Nm



Watchet NE-9004 1pc



Air drill QE-2132 1pc



Angle Grinder QB-9903 1pc



Exhaust



Die Grinder QA-9120 1pc



Angle Die Grinder QA-9620 1pc

	Cylinder Power	Chuck Capacity	Free Speed	Net Weight	Overall Length	Avg. Air Consumption	Air Pressure	Air Inlet Size	Air Hose	Sound Pressure
	hp(w)	Inch (mm)	R.P.M	kg	mm	(L/min)	PSI (bar)	Inch	Inch	dBA
QA-9120	0.5(372)	1/4" & 1/8" (6mm & 3mm)	20,000	0.73	202	5	90(6.3)	1/4"	3/8"	82
NE-9004	0.5(372)	1/2"(13)	150	1.488	287	5	90(6.3)	1/4"	3/8"	82
QE-2132	0.5(372)	3/8"(10)	2500	1.143	248	5	90(6.3)	1/4"	3/8"	82
QB-9903	0.5(372)	PAD DIA 3"(76)	14,000	0.976	211	5	90(6.3)	1/4"	3/8"	82
QA-9620	0.5(372)	1/4" & 1/8" (6mm & 3mm)	14,000	0.89	208	5	90(6.3)	1/4"	3/8"	82

**NEW PRODUCT**

★★★  **NE-2905**

1/4" DRIVE Air inlet : 1/4"

5" extended



★★★  **NE-3310 / 4310**

3/8" & 1/2" DRIVE Air inlet : 1/4"

10" extended



★★★  **NE-2803 / 3803**

1/4" & 3/8" DRIVE Air inlet : 1/4"



★★★  **NE-3808 / 4808**

3/8" & 1/2" DRIVE Air inlet : 1/4"



	Square Drive	Torque Range	Max Torque	Free Speed	Avg. Air Consumption	Air Pressure	Overall Length	Net Weight	Air Hose	Sound Pressure	Vibration Level
	Inch	FT-LB (Nm)	FT-LB Nm	R.P.M	CFM (L/min)	PSI (bar)	Inch (mm)	LBS kg	Inch	dBA	m/s <sup>2</sup>
NE-2905	1/4"	5-15(7-20)	22 30	300	3.0(85)	90 (6.3)	11-1/2"(290)	1.85 0.84	3/8"	89	4.4
NE-3310	3/8"	15-55(70-75)	70 95	160	4.0(113)	90 (6.3)	20-7/8"(530)	3.85 1.75	3/8"	82	1.2
NE-4310	1/2"	15-55(20-75)	70 95	160	4.0(113)	90 (6.3)	20-7/8"(530)	3.85 1.75	3/8"	82	1.2
NE-2803	1/4"	5-15(7-20)	35 47.6	300	3.6(102)	90 (6.3)	8-1/2"(220)	1.39 0.63	3/8"	92.8	3.2
NE-3803	3/8"	5-30(7-40)	35 47.6	300	3.6(102)	90 (6.3)	8-1/2"(220)	1.39 0.63	3/8"	92.0	3.2
NE-3808	3/8"	10-55(13.5-74)	80 108.8	180	4.0(113)	90 (6.3)	12"(300)	2.77 1.26	3/8"	95.0	3.6
NE-4808	1/2"	10-55(13.5-74)	80 108.8	180	4.0(113.28)	90 (6.3)	12"(280)	2.77 1.26	3/8"	95.0	3.6

# AIR DIE GRINDER



## QA-1211 / QA-1221 A/B QA-2211 / QA-2221 A/B

AIR DIE GRINDER  
Safety Lever Type Throttle  
Air inlet : 1/4"



## QA-131 A/B

AIR DIE GRINDER Air inlet : 1/4"  
Roll Type Throttle



## QA-141 A/B QA-141L A/B

AIR DIE GRINDER Air inlet : 1/4"  
QA-141-Roll Type Throttle  
QA-141L-Lever Type Throttle



## QA-151 A/B

AIR DIE GRINDER Air inlet : 1/4"  
Roll Type Throttle



## QA-633Q A/B

97° Air Angle Die Grinder  
Air inlet : 1/4"



## QA-681 A/B

AIR ANGLE DIE GRINDER  
Air inlet : 1/4"  
Stylized grip



## QA-163 A/B QA-163L A/B

AIR DIE GRINDER Air inlet : 3/8"  
QA-163-Roll Type Throttle  
QA-163L-Lever Type Throttle



## QA-143 A/B

AIR DIE GRINDER Air inlet : 1/4"  
Roll Type Throttle





## QA-1710A/B

EXTENDED AIR DIE GRINDER Air inlet : 1/4"



## QA-632Q A/B

97°AIR ANGLE DIE GRINDER Air inlet : 1/4"



## QA-611 A/B

90°AIR ANGLE DIE GRINDER Air inlet : 1/4"



	Collet Size A mm	Collet Size B inch	Free Speed R.P.M	Avg. Air Consumption CFM (L/min)	Air Pressure PSI (bar)	Overall Length Inch (mm)	Motor HP	Net Weight LBS(kg)		Air Hose Inch	Sound Pressure dBA	Vibration Level m/s <sup>2</sup>
QA-1211	3	1/8"	25000	14	90 (6.3)	7-11/16"(196)	0.4	1.1	0.49	3/8"	68	0.9
QA-1221	6	1/4"	25000	14	90 (6.3)	7-11/16"(196)	0.4	1.1	0.49	3/8"	68	0.9
QA-2211	3	1/8"	20000	14	90 (6.3)	8-7/16"(215)	0.6	1.6	0.71	3/8"	75	0.9
QA-2221	6	1/4"	20000	14	90 (6.3)	8-7/16"(215)	0.6	1.6	0.71	3/8"	75	0.9
QA-633Q	6 & 3	1/4" & 1/8"	15000	17.2(490)	90(6.3)	7-1/8"(180)	0.6	1.54	0.70	3/8"	78	2.5
QA-131	3	1/8"	30000	14.0(396)	90(6.3)	6-11/16"(170)	0.4	1.3	0.60	3/8"	75.0	2.5
QA-681	6 & 3	1/4" & 1/8"	20000	5.0(141)	90(6.3)	7-11/16" (195)	0.5	1.76	0.8	3/8"	85.0	1.8
QA-141	6	1/4"	24000	14.0(396)	90(6.3)	6-11/16"(170)	0.4	1.3	0.60	3/8"	75.0	2.5
QA-141L	6	1/4"	24000	14.0(396)	90(6.3)	6-11/16"(170)	0.4	1.3	0.60	3/8"	75.0	2.5
QA-143	6	1/4"	24000	14.0(396)	90(6.3)	11-11/16"(296)	0.4	2.0	0.90	3/8"	75.0	2.5
QA-151	6	1/4"	18000	12.2(345)	90(6.3)	7"(177)	0.9	1.76	0.80	3/8"	75.0	2.1
QA-163	6	1/4"	16000	5.0(141)	90(6.3)	12"(305)	0.9	2.7	1.25	3/8"	90.0	2.8
QA-163L	6	1/4"	16000	5.0(141)	90(6.3)	13-25/32"(350)	0.9	2.9	1.31	3/8"	90.0	2.8
QA-1710	6	1/4"	18000	5.0(141)	90(6.3)	18-5/16"(465)	0.4	2.36	1.07	3/8"	80.0	1.5
QA-632Q	6 & 3	1/4" & 1/8"	22000	12.3(350)	90(6.3)	7"(177)	0.4	1.12	0.51	3/8"	75.0	2.5
QA-611	6 & 3	1/4" & 1/8"	19000	10.0(283)	90(6.3)	6-1/8"(160)	0.3	1.12	0.51	3/8"	74.4	1.7

# AIR DIE GRINDER



## QA-110 A / B

AIR DIE GRINDER Air inlet : 1/4"

*Stylized grip*



## QA-101 A / B

AIR DIE GRINDER Air inlet : 1/4"



## QA-111 A / B

AIR DIE GRINDER Air inlet : 1/4"



## QA-210 A / B

AIR DIE GRINDER Air inlet : 1/4"

*Keyless Collet*



## QA-211 A / B

AIR DIE GRINDER Air inlet : 1/4"



## QA-241 A / B

AIR DIE GRINDER Air inlet : 1/4"



## QA-231Q A / B

AIR DIE GRINDER Air inlet : 1/4"



## QA-311 A / B

AIR DIE GRINDER Air inlet : 1/4"



## QA-313 A / B

AIR DIE GRINDER Air inlet : 1/4"



## QA-315 A / B

AIR DIE GRINDER Air inlet : 1/4"



AIR DIE GRINDER





## QA-6205 A / B

Extended 90° Air Angle Die Grinder  
Safety Lever Type Throttle  
Air inlet : 1/4"



Exhaust

360° Swivel Exhaust

6"(152mm) extended



## QA-116 A / B

AIR DIE GRINDER Air inlet : 1/4"



Exhaust

Stylized grip



## QA-0115 A / B QA-0215 A / B

AIR DIE GRINDER 15PCS KIT

Air inlet : 1/4"

- 1pc Air Die Grinder (QA-111 / 211)
- 1pc Collet (3 mm or 1/8")
- 2pcs Spanner Wrench
- 5pcs Grinding Stone (3 mm or 1/8")
- 5pcs Grinding Stone (6mm or 1/4")
- 1pc Plug (adapter)



## QA-0615 A / B

AIR DIE GRINDER 15PCS KIT

Air inlet : 1/4"

- 1pc Air Die Grinder (QA-611)
- 1pc Collet (3 mm or 1/8")
- 2pcs Spanner Wrench
- 5pcs Grinder Stone (3 mm or 1/8")
- 5pcs Grinder Stone (6 mm or 1/4")
- 1pc Plug (adapter)



## QA-0207 A / B

AIR DIE GRINDER 7PCS KIT

Air inlet : 1/4"

- 1pc Air Die Grinder (QA-210)
- 5pcs Grinder stone (6mm or 1/4")
- 1pc Plug (adapter)



	Collet Size A mm	Collet Size B inch	Free Speed R.P.M	Avg. Air Consumption CFM (L/min)	Air Pressure PSI (bar)	Overall Length Inch (mm)	Motor HP	Net Weight LBS(kg)	Air Hose Inch	Sound Pressure dBA	Vibration Level m/s <sup>2</sup>	
QA-6205	6	1/4"	14500	3.5	90 (6.3)	12-1/8"(308)	0.5	2.09	0.95	3/8"	--	
QA-110	6 & 3	1/4" & 1/8"	22000	5.0(141)	90 (6.3)	7-5/16"(186)	0.5	1.36	0.62	3/8"	85.0	1.1
QA-101	6 & 3	1/4" & 1/8"	25000	6.3(178)	90(6.3)	4-11/16"(119)	0.3	0.71	0.32	3/8"	80.0	1.4
QA-111	6 & 3	1/4" & 1/8"	25000	10.0(283)	90(6.3)	6"(155)	0.3	0.8	0.38	3/8"	81.5	1.8
QA-210	6	1/4"	20000	10.0(283)	90(6.3)	7-1/2"(190)	0.9	1.4	0.65	3/8"	75.7	0.8
QA-211	6 & 3	1/4" & 1/8"	20000	10.0(283)	90(6.3)	7-1/2"(190)	0.9	1.4	0.65	3/8"	75.7	0.8
QA-231Q	6 & 3	1/4" & 1/8"	20000	14.8(420)	90(6.3)	5-29/32"(150)	0.45	0.8	0.35	3/8"	80.0	>2.5
QA-241	6	1/4"	4000	10.6(283)	90(6.3)	8-5/8"(220)	0.5	1.6	0.75	3/8"	75.0	0.87
QA-311	6 & 3	1/4" & 1/8"	25000	10.0(283)	90(6.3)	7-1/2"(190)	0.3	1.0	0.48	3/8"	81.5	1.8
QA-313	6 & 3	1/4" & 1/8"	25000	10.0(283)	90(6.3)	9-1/4"(235)	0.3	1.2	0.58	3/8"	81.5	1.8
QA-315	6 & 3	1/4" & 1/8"	25000	10.0(283)	90(6.3)	11"(280)	0.3	1.4	0.63	3/8"	81.5	1.8
QA-116	6 & 3	1/4" & 1/8"	22000	5.0(141)	90 (6.3)	13-9/16"(345)	0.5	2.53	1.15	3/8"	85.0	1.8

AIR DIE GRINDER

# MICRO AIR DIE GRINDER

MICRO AIR DIE GRINDER



## QA-4507

A:6mm B:1/4"  
MICRO AIR DIE GRINDER  
Air inlet : 1/4"



## QA-412

A:3mm B:1/8"  
MICRO AIR DIE GRINDER  
Air inlet : 1/4"



## QA-421

A:3mm B:1/8"  
MICRO AIR DIE GRINDER  
Air inlet : 1/4"



## QA-431

A:3mm B:1/8"  
MICRO AIR DIE GRINDER  
Air inlet : 1/4"



## QA-432

A:3mm B:1/8"  
MICRO AIR DIE GRINDER  
Air inlet : 1/4"



## QA-511

ENGRAVING PEN  
Air inlet : 1/4"



## QA-441

A:3mm B:1/8"  
MICRO AIR DIE GRINDER  
Air inlet : 1/4"



	Collet Size inch(mm)	Free Speed R.P.M	Blow Per Minute bpm	Avg. Air Consumption CFM (L/min)	Air Pressure PSI (bar)	Overall Length Inch (mm)	Hose Length mm	Net Weight LBS(kg)	Air Hose Inch	Sound Pressure dBA	Vibration Level m/s <sup>2</sup>
QA-4507	1/4" (6)	32000	-----	4.0(113)	90(6.3)	14-11/32"(364)	1500	0.88 0.40	3/8"	85.0	1.2
QA-412	1/8" (3)	60000	-----	2.7(76)	90(6.3)	6-3/4"(170)	1500	0.50 0.22	3/8"	70.0	0.5
QA-421	1/8" (3)	60000	-----	2.7(76)	90(6.3)	6"(150)	1500	0.50 0.22	3/8"	70.0	0.5
QA-431	1/8" (3)	54000	-----	2.0(56)	90(6.3)	5-3/8"(137)	1425	0.40 0.18	3/8"	70.0	0.5
QA-432	1/8" (3)	70000	-----	1.0(29)	90(6.3)	5-3/8"(137)	1425	0.40 0.18	3/8"	70.0	0.5
QA-511	-----	-----	13000	1.0(29)	90(6.3)	5-1/2"(140)	1420	0.50 0.22	3/8"	78.0	0.6
QA-441	1/8" (3)	60000	-----	2.0(56)	90(6.3)	5-5/16"(135)	1500	0.40 0.18	3/8"	71.0	1.0

# AIR ANGLE GRINDER

• Note : The grinding wheel is not supplied along with the tool



## QB-7315 S/M

2.3hp Air Angle Grinder / Lever Type Throttle  
Air inlet : 1/4"



## QB-7114 S/M QB-7145 S/M QB-7115 S/M

100° 1.3hp Air Angle Grinder / Lever Type Throttle  
Air inlet : 1/4"



## QB-194 / QB-194L

Roll Type / Lever Type Throttle  
Air inlet : 3/8"



## QB-192 / QB-192L

Roll Type / Lever Type Throttle  
Air inlet : 3/8"



## QB-193 / QB-193L

Roll Type / Lever Type Throttle  
Air inlet : 3/8"



	Pad Dia inch(mm)	Spindle Size	Free Speed R.P.M	Avg. Air Consumption CFM (L/min)	Air Pressure PSI (bar)	Overall Length Inch (mm)	Motor HP	Net Weight LBS(kg)	Air Hose Inch	Sound Pressure dBA	Vibration Level m/s²
QB-7315M	5"	M14*P2.0	10000	6.9(195)	90(6.3)	9-1/4"(234)	2.3	4.0 1.8	1/2"	88	3.8
QB-7315S	127	5/8"-11	10000	6.9(195)	90(6.3)	9-1/4"(234)	2.3	4.0 1.8	1/2"	88	3.8
QB-7114(S/M)	4"(100)	3/8"-24 / M10*P1.5	11000	4.2(119)	90(6.3)	9-1/8"(232)	1.30	4.0 1.81	3/8"	90.0	1.2
QB-7145(S/M)	4-1/2"(114)	5/8"-11 / M14*P2.0	11000	4.2(119)	90(6.3)	9-1/8"(232)	1.30	4.0 1.81	3/8"	90.0	1.2
QB-7115(S/M)	5"(125)	5/8"-11 / M14*P2.0	11000	4.2(119)	90(6.3)	9-1/8"(232)	1.30	4.0 1.81	3/8"	90.0	1.2
QB-194	4"(100x16)	M8 X 1.25	12000	4.9(138)	90(6.3)	8-15/32"(215)	0.9	4.2 1.9	3/8"	91.0	2.6
QB-194L	4"(100x16)	M8 X 1.25	12000	4.9(138)	90(6.3)	10-23/32"(272)	0.9	4.6 2.1	3/8"	89.0	2.5
QB-192	2"(50)	1/4"-28	15000	5.3(150)	90 (6.3)	6-1/8"(154)	0.36	1.3 0.6	3/8"	81	2
QB-193	3"(75)	M8	13500	5.8(164)	90 (6.3)	7-1/8"(180)	0.44	2.4 1.1	3/8"	85	2.5

# AIR ANGLE GRINDER

• Note : The grinding wheel is not supplied along with the tool

MICRO AIR DIE GRINDER



## QB-104X/105X

ROLL TYPE THROTTLE  
Air inlet : 1/4"



## QB-114X/115X

ROLL TYPE THROTTLE  
Air inlet : 1/4"



## QB-124/125

ROLL TYPE THROTTLE  
Air inlet : 1/4"



## QB-134X/135X QB-154X/155X

ROLL TYPE THROTTLE  
Air inlet : 1/4"



## QB-144X/145X QB-164X/165X

ROLL TYPE THROTTLE  
Air inlet : 1/4"



## QB-117

ROLL TYPE THROTTLE  
Air inlet : 1/4"



## QB-177

ROLL TYPE THROTTLE  
Air inlet : 1/4"



## QB-197Q

LEVER TYPE THROTTLE  
Air inlet : 3/8"



## QB-199 S/M

LEVER TYPE THROTTLE  
Air inlet : 3/8"



## QB-179

AIR VERTICAL GRINDER  
LEVER TYPE THROTTLE  
Air inlet : 1/2"



## QB-185

AIR VERTICAL GRINDER  
LEVER TYPE THROTTLE  
Air inlet : 3/8"



## QB-187

AIR VERTICAL GRINDER  
LEVER TYPE THROTTLE  
Air inlet : 3/8"





● Note : The grinding wheel is not supplied along with the tool

★★★  
**QB-194-CN**  
**ROLL TYPE THROTTLE**  
 Air inlet : 3/8"



★★★  
**QB-195-CN**  
**ROLL TYPE THROTTLE**  
 Air inlet : 3/8"



	Pad Dia / Arbor Size	Spindle Size	Free Speed	Avg. Air Consumption	Air Pressure	Overall Length	Motor	Net Weight		Air Hose	Sound Pressure	Vibration Level
	inch(mm)		R.P.M	CFM (L/min)	PSI (bar)	Inch (mm)	HP	LBS(kg)		Inch	dBA	m/s <sup>2</sup>
QB-104X	4"(100x16)	3/8"-24	11000	6.0(170)	90(6.3)	8-7/8"(226)	0.78	4.0	1.81	3/8"	87.8	1.2
QB-105X	5"(125x22)	5/8"-11	11000	6.0(170)	90(6.3)	8-7/8"(226)	0.78	4.0	1.81	3/8"	87.1	1.2
QB-114X	4"(100x16)	3/8"-24	11000	6.0(170)	90(6.3)	9"(230)	0.78	4.0	1.81	3/8"	87.8	1.2
QB-115X	5"(125x22)	5/8"-11	11000	6.0(170)	90(6.3)	9"(230)	0.78	4.0	1.81	3/8"	87.1	1.2
QB-124	4"(100x16)	3/8"-24	11000	6.0(170)	90(6.3)	9"(230)	0.80	3.8	1.73	3/8"	85.7	3.0
QB-125	5"(125x22)	5/8"-11	11000	6.0(170)	90(6.3)	9"(230)	0.80	3.9	1.78	3/8"	87.0	5.9
QB-134X	4"(100x16)	M10xP1.5	11000	6.0(170)	90(6.3)	9"(230)	0.78	4.0	1.81	3/8"	87.8	1.2
QB-135X	5"(125x22)	M14xP2.0	11000	6.0(170)	90(6.3)	9"(230)	0.78	4.0	1.81	3/8"	87.1	1.2
QB-144X	4"(100x16)	M10xP1.5	11000	6.0(170)	90(6.3)	8-7/8"(226)	0.78	4.0	1.81	3/8"	87.8	1.2
QB-145X	5"(125x22)	M14xP2.0	11000	6.0(170)	90(6.3)	8-7/8"(226)	0.78	4.0	1.81	3/8"	87.8	1.2
QB-154X	4"(100x16)	3/8"-24	11000	6.0(170)	90(6.3)	9"(230)	0.78	3.8	1.73	3/8"	87.8	1.2
QB-155X	5"(125x22)	5/8"-11	11000	6.0(170)	90(6.3)	9"(230)	0.78	3.9	1.78	3/8"	87.8	1.2
QB-164X	4"(100x16)	3/8"-24	11000	6.0(170)	90(6.3)	8-7/8"(226)	0.78	4.0	1.81	3/8"	87.8	1.2
QB-165X	5"(125x22)	5/8"-11	11000	6.0(170)	90(6.3)	8-7/8"(226)	0.78	4.0	1.81	3/8"	87.8	1.2
QB-117	7"(178x22)	-----	7000	9.0(255)	90(6.3)	13-1/2"(343)	1.0	7.1	3.22	1/2"	89.7	1.0
QB-177	7"(178x22)	5/8"-11	7600	6.0(170)	90(6.3)	11-13/16"(300)	2.0	7.2	3.3	3/8"	92.0	2.7
QB-197Q	7"(178x22)	5/8"-11	7000	6.0(170)	90(6.3)	13-15/16"(353)	2.2	6.8	3.1	3/8"	77.0	2.4
QB-199S	9"(230x22)	5/8"	5900	6.8(178)	90(6.3)	14"(360)	2.5	9.9	4.5	3/8"	98.0	3.75
QB-199M	9"(230x22)	M14 X P2.0	5900	6.8(178)	90(6.3)	14"(360)	2.5	9.9	4.5	3/8"	98.0	3.75
QB-179	9"(230x22)	5/8"-11	6000	7.0(198)	90(6.3)	11"(279)	3.8	13.2	6.0	3/4"	86.0	2.1
QB-185	5"(125x22)	5/8"-11	12000	6.0(170)	90(6.3)	9-9/64"(232)	1.4	6.2	2.8	1/2"	86.0	2.1
QB-187	7"(178x22)	5/8"-11	7000	6.0(170)	90(6.3)	9-23/32"(247)	2.0	8.8	4.0	1/2"	86.0	2.1

AIR ANGLE GRINDER

# AIR ANGLE GRINDER



## QB-1004

ROLL TYPE THROTTLE  
Air inlet : 1/4"



## QB-623

2" AIR ANGLE GRINDER  
Lever Type Throttle  
Air inlet : 1/4"



Note : The grinding wheel is not supplied along with the tool



## QB-195L-85 QB-195L-120

LEVER TYPE THROTTLE  
Air inlet : 3/8"



## QB-195-85 QB-195-120

ROLL TYPE THROTTLE  
Air inlet : 3/8"



Note : The grinding wheel is not supplied along with the tool

Note : The grinding wheel is not supplied along with the tool



## QB-2925

AIR STRAIGHT GRINDER  
ROLL TYPE THROTTLE  
Air inlet : 3/8"



Used With Straight Grinding Wheel

Note : The grinding wheel is not supplied along with the tool



## QB-2925L

AIR STRAIGHT GRINDER  
LEVER TYPE THROTTLE  
Air inlet : 3/8"



Used With Straight Grinding Wheel

Note : The grinding wheel is not supplied along with the tool

Pad Dia / Arbor Size	Spindle Size	Free Speed	Avg. Air Consumption	Air Pressure	Overall Length	Motor	Net Weight	Air Hose	Sound Pressure	Vibration Level		
inch(mm)		R.P.M	CFM (L/min)	PSI (bar)	Inch (mm)	HP	LBS(kg)	Inch	dBA	m/s <sup>2</sup>		
QB-1004	4" (100x16)	M8 X 1.25	13500	4.9(138)	90(6.3)	7-3/32"(215)	0.6	2.6	1.2	3/8"	85.0	2.5
QB-2925	(65x13x9.5)	M10 X 1.5	16000	5.0(141)	90(6.3)	10-11/16"(270)	0.9	2.9	1.33	3/8"	90.0	2.8
QB-2925L	(65x13x9.5)	M10 X 1.5	16000	5.0(141)	90(6.3)	12-25/32"(324)	0.9	3.0	1.39	3/8"	90.0	2.8
QB-623	2"(50x10)	M14 X P2.0	19000	8.1(283)	90(6.3)	6-5/16"(160)	0.3	1.2	0.57	3/8"	80.0	0.5
QB-194-CN	4"(100x16)	M8 X 1.25	13500	4.8(136)	90(6.3)	8-15/64"(210)	0.8	4.2	1.9	3/8"	92.0	2.8
QB-195-CN	5"(125x22)	1/2"-13	12000	4.9(138)	90(6.3)	8-15/32"(215)	1.0	4.4	2.0	3/8"	91.0	2.6
QB-195-85	5"(125x22)	1/2"-13	8500	4.9(138)	90(6.3)	8-15/16"(227)	1.4	5.3	2.4	3/8"	91.0	2.1
QB-195-120	5"(125x22)	1/2"-13	12000	5.1(144)	90(6.3)	10-13/16"(275)	1.4	5.5	2.5	3/8"	91.0	2.1



## QB-311

AIR BELT SANDER  
Air inlet : 1/4"



## QB-312

AIR BELT SANDER  
Air inlet : 1/4"



## QB-313

AIR BELT SANDER  
Air inlet : 1/4"



## QB-321

AIR BELT SANDER  
Air inlet : 1/4"



## QB-324

AIR BELT SANDER  
Air inlet : 1/4"



## QB-322 QB-322C

AIR BELT SANDER  
Air inlet : 1/4"



## QB-322RC

AIR BELT SANDER - ANGLE FELXIBLE  
Air inlet : 1/4"



## QB-325N[SET]

AIR BELT SANDER  
Air inlet : 1/4"



	Belt Size Pad Dia inch(mm)	Free Speed R.P.M	Avg. Air Consumption CFM (L/min)	Air Pressure PSI (bar)	Overall Length Inch (mm)	Net Weight LBS kg	Air Hose Inch	Sound Pressure dBA	Vibration Level m/s <sup>2</sup>
QB-311	3/8"x13"(10x330)	16000	8.0(226)	90(6.3)	11-1/2"(290)	1.76 0.80	3/8"	89.7	0.5
QB-312	3/4"x20-1/2"(20x520)	16000	9.0(254)	90(6.3)	14"(360)	2.65 1.20	3/8"	91.8	0.4
QB-313	1-3/16"x21-1/4"(30x540)	13000	10.0(283)	90(6.3)	15-3/8"(390)	5.28 2.40	3/8"	81.0	1.2
QB-321	3/8"x13"(10x330)	16000	4.0(113)	90(6.3)	12-5/8"(320)	2.1 0.95	3/8"	88.0	1.0
QB-322	3/4"x20-1/2"(20x520)	16000	4.0(113)	90(6.3)	17"(430)	3.1 1.40	3/8"	88.0	1.3
QB-322RC	3/4"x20"-1/2"(20x520)	16000	4.0(113)	90(6.3)	17"(430)	3.1 1.40	3/8"	88.0	1.3
QB-324	1/2"x24"(12.7x610)	16000	4.0(113)	90(6.3)	18"(455)	2.4 1.10	3/8"	88.0	1.1
QB-325N	3/8"x13" (10X330)	16000	4.0(113)	90(6.3)	12-5/8"(320)	2.1 0.95	3/8"	90	1.1
[QB-325P04]	1/4"x13" (6X330)								
[QB-325P52]	3/4"x13" (20X330)								
[QB-325P53]	3/4"x20-1/2" (20X520)								
[QB-325P54]									

AIR BELT SANDER

# AIR SANDER



## QB-51612 QB-51602

**AIR RANDOM ORBITALS  
CENTRAL-VACUUM**

Air inlet : 1/4"



## QB-20203

**AIR RANDOM ORBITAL SANDER**

Air inlet : 1/4"



Note : 2" Sanding Pad & 3" Sanding Pad is supplied along with the tool

	Pad Dia	Free Speed	Avg. Air Consumption	Air Pressure	Overall Length	Motor	Net Weight		Air Hose	Sound Pressure	Vibration Level	orbit
	inch(mm)	R.P.M	CFM (L/min)	PSI (bar)	Inch (mm)	HP	LBS(kg)		Inch	dBA	m/s <sup>2</sup>	mm
QB-51612	6"(152)	12000	3.0(85)	90(6.3)	8-7/8"(225)	0.24	2 0.9		3/8"	81.6	1.5	2.5
QB-51602	6"(152)	12000	3.0(85)	90(6.3)	8-7/8"(225)	0.24	2 0.9		3/8"	81.6	1.5	5.0
QB-20203	2" + 3"	14000	3.0(85)	90(6.3)	5-1/8"(130)	----	1.1 0.5		3/8"	81.6	1.5	3.0



## Non-Vacuum SERIES



## QB-42

5" QB-42502 5mm orbit  
6" QB-42602 5mm orbit

**AIR RANDOM ORBITAL SANDER  
Non-Vacuum**

Air inlet : 1/4"



## QB-46

5" QB-46502 5mm orbit  
5" QB-46512 2.5mm orbit  
6" QB-46602 5mm orbit  
6" QB-46612 2.5mm orbit

**Air Random Orbital Sander  
Non-Vacuum**

Air inlet : 1/4"



## 6"QB-49602

**Dual Action Sander  
Non-vacuum 9.5mm orbit**  
Air inlet : 1/4"







## QB-52

5" QB-52502 5mm orbit  
 6" QB-52602 5mm orbit  
 Air Random Orbital Sander  
 Non-Vacuum  
 Air inlet : 1/4"



## QB-55

5" QB-55502 5mm orbit  
 6" QB-55602 5mm orbit  
 Air Random Orbital Sander  
 Non-Vacuum  
 Air inlet : 1/4"



## 5" QB-58502 6" QB-58602

Air 2-Hand Random Orbital Sander  
 Non-Vacuum 5mm orbit  
 Air inlet : 1/4"



## Non-Vacuum Sander Accessories

Velcro Or Vinyl Sanding Pad Both Available

Backing Face : velcro



Blister+Card

ITEM NO.	SIZE	Max R.P.M
QB-9302	2"	15000
QB-9303	3"	15000
QB-9305	5"	12000
QB-9306	6"	12000

Backing Face : vinyl



Blister+Card

ITEM NO.	SIZE	Max R.P.M
QB-9345	5"	12000
QB-9346	6"	12000

	Pad Dia	Free Speed	Avg. Air Consumption	Air Pressure	Overall Length	Motor	Net Weight	Air Hose	Sound Pressure	Vibration Level	orbit
	inch(mm)	R.P.M	CFM (L/min)	PSI (bar)	Inch (mm)	HP	LBS(kg)	Inch	dBA	m/s <sup>2</sup>	mm
QB-42502	5"(127)	10000	3.85(109)	90(6.3)	6"(153)	0.24	1.7 0.81	3/8"	75.7	1.4	5
QB-42602	6"(152)	10000	3.85(109)	90(6.3)	6-1/2"(166)	0.24	1.8 0.85	3/8"	74.4	1.4	5
QB-46502	5"(127)	10000	3.85(109)	90(6.3)	6"(153)	0.24	1.74 0.79	3/8"	80.1	2.2	5
QB-46512	5"(127)	10000	3.85(109)	90(6.3)	6"(153)	0.24	1.74 0.79	3/8"	80.1	2.2	2.5
QB-46602	6"(152)	10000	3.85(109)	90(6.3)	6-1/2"(166)	0.24	1.74 0.79	3/8"	80.1	2.2	5
QB-46612	6"(152)	10000	3.85(109)	90(6.3)	6-1/2"(166)	0.24	1.74 0.79	3/8"	80.1	2.2	2.5
QB-49602	6"(152)	10000	3.60(102)	90(6.3)	8-21/32"(220)	0.75	2.0 0.9	3/8"	92.5	3.3	9.5
QB-52502	5"(127)	10000	6.0(170)	90(6.3)	6"(153)	0.24	2.2 1.00	3/8"	87.6	1.2	5
QB-52602	6"(152)	10000	6.0(170)	90(6.3)	6-1/2"(166)	0.24	2.65 1.20	3/8"	87.6	1.7	5
QB-55502	5"(127)	10000	3.0(85)	90(6.3)	6-11/16"(170)	0.24	1.5 0.68	3/8"	81.6	1.5	5
QB-55602	6"(152)	10000	3.0(85)	90(6.3)	6-11/16"(170)	0.24	1.5 0.68	3/8"	81.6	1.5	5
QB-58502	5"(127)	10000	3.10(88)	90(6.3)	9-7/16"(240)	0.4	2.6 1.2	3/8"	80.0	1.3	5
QB-58602	6"(152)	10000	3.10(88)	90(6.3)	9-7/16"(240)	0.4	2.6 1.2	3/8"	80.0	1.3	5

# AIR SANDER

## Self-Generated Vacuum SERIES

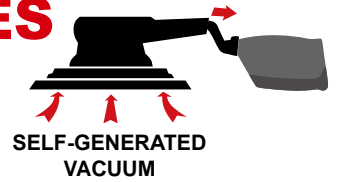

### QB-43

5" QB-43802 5mm orbit  
6" QB-43902 5mm orbit

Air Random Orbital Sander  
Self-Generated Vacuum

Air inlet : 1/4"



### QB-47

6" QB-47602 5mm orbit  
6" QB-57612 2.5mm orbit

Air Random Orbital Sander  
Self-Generated Vacuum

Air inlet : 1/4"



### QB-53

5" QB-53802 5mm orbit  
6" QB-53902 5mm orbit

Air Random Orbital Sander  
Self-Generated Vacuum

Air inlet : 1/4"



### QB-56602

5" QB-56502 5mm orbit  
6" QB-56602 5mm orbit

Air Random Orbital Sander  
Self-Generated Vacuum 5mm orbit

Air inlet : 1/4"



### 6" QB-59602

AIR 2-HAND Air Random Orbital Sander  
Self-Generated Vacuum 5mm orbit

Air inlet : 1/4"



Air Regulator

	Pad Dia	Free Speed	Avg. Air Consumption	Air Pressure	Overall Length	Motor	Net Weight		Air Hose	Sound Pressure	Vibration Level	orbit
	inch(mm)	R.P.M	CFM (L/min)	PSI (bar)	Inch (mm)	HP	LBS(kg)		Inch	dBA	m/s <sup>2</sup>	mm
QB-43802	5"(127)	10000	3.85(109)	90(6.3)	8"(206)	0.24	3.28	1.49	3/8"	83.9	1.3	5
QB-43902	6"(152)	10000	3.85(109)	90(6.3)	8-3/4"(221)	0.24	3.39	1.54	3/8"	83.0	1.4	5
QB-47602	6"(152)	10000	3.85(109)	90(6.3)	7-1/2"(193)	0.24	2.49	1.13	3/8"	84.7	2.2	5
QB-47612	6"(152)	10000	3.85(109)	90(6.3)	7-1/2"(193)	0.24	2.49	1.13	3/8"	84.7	2.2	2.5
QB-53802	5"(127)	10000	6(170)	90(6.3)	6"(153)	0.24	2.2	1.00	3/8"	86.2	1.1	5
QB-53902	6"(152)	10000	6(170)	90(6.3)	6-1/2"(166)	0.24	2.65	1.20	3/8"	80.1	1.2	5
QB-56502	5"(127)	10000	3.0(85)	90(6.3)	8-1/4"(210)	0.24	1.7	0.78	3/8"	81.6	1.5	5
QB-56602	6"(152)	10000	3.0(85)	90(6.3)	8-1/4"(210)	0.24	1.7	0.78	3/8"	81.6	1.5	5
QB-59602	6"(152)	10000	3.10(88)	90(6.3)	9-7/16"(240)	0.4	2.6	1.2	3/8"	80.0	1.3	5
QB-57602	6"(152)	10000	3.10(88)	90(6.3)	9-7/16"(240)	0.40	2.6	1.2	3/8"	80.0	1.3	5

# Central-Vacuum SERIES



CENTRAL-VACUUM



## 6" QB-57602

**AIR 2-HAND**  
Air Random Orbital Sander  
Central-Vacuum 5mm orbit  
Air inlet : 1/4"



Air Regulator



## QB-41

6" QB-41902 5mm orbit  
Air Random Orbital Sander  
Central-Vacuum  
Air inlet : 1/4"



## QB-54

6" QB-54602 (six hole Pad)  
6" QB-54702 (fifteen hole Pad)  
Air Random Orbital Sander  
Central-Vacuum  
Air inlet : 1/4"



## QB-45

6" QB-45602 5mm orbit  
6" QB-45612 2.5mm orbit  
Air Random Orbital Sander  
Central-Vacuum  
Air inlet : 1/4"



# AIR GEAR DRIVER SANDER



GEAR DRIVEN



## 6" QB-57642

**AIR 2-HAND**  
Air Random Orbital Sander  
Central-Vacuum  
Air inlet : 1/4"



QB-57642P39

Equipped with QB-57642P39  
6-hole Vacuum Pad



## 6" QB-59642

**AIR 2-HAND**  
Air Random Orbital Sander  
Self-Generated Vacuum  
Air inlet : 1/4"



QB-59642P39

Equipped with QB-59642P39  
6-hole Vacuum Pad



## 5" QB-58542 6" QB-58642

**AIR 2-HAND** Random Orbital Sander  
Non-Vacuum 5mm orbit Air inlet : 1/4"



5" QB-58542P39  
6" QB-58642P39

Equipped with QB-58642P39  
Non-Vacuum Pad

	Pad Dia	Free Speed	Avg. Air Consumption	Air Pressure	Overall Length	Motor	Net Weight	Air Hose	Sound Pressure	Vibration Level	orbit
	inch(mm)	R.P.M	CFM (L/min)	PSI (bar)	Inch (mm)	HP	LBS(kg)	Inch	dBA	m/s <sup>2</sup>	mm
QB-41902	6"(152)	10000	3.85(109)	90(6.3)	8"(206)	0.24	2.0 0.91	3/8"	81.5	1.2	5
QB-45602	6"(152)	10000	3.85(109)	90(6.3)	7-1/2"(193)	0.24	1.85 0.84	3/8"	81.6	2.2	5
QB-45612	6"(152)	10000	3.85(109)	90(6.3)	7-1/2"(193)	0.24	1.85 0.84	3/8"	81.6	2.2	2.5
QB-54602	6"(152)	10000	3.0(85)	90(6.3)	8-1/4"(210)	0.24	1.7 0.78	3/8"	81.6	1.5	5
QB-54702	6"(152)	10000	3.0(85)	90(6.3)	8-1/4"(210)	0.24	1.7 0.78	3/8"	81.6	1.5	5
QB-57642	6"(152)	900	3.10(88)	90(6.3)	9-7/16"(240)	0.4	3.5 1.6	3/8"	82.0	<2.5	5
QB-59642	6"(152)	900	3.10(88)	90(6.3)	9-7/16"(240)	0.4	3.5 1.6	3/8"	82.0	<2.5	5
QB-58542	5"(127)	900	3.10(88)	90(6.3)	9-7/16"(240)	0.4	3.3 1.5	3/8"	82.0	<2.5	5
QB-58642	6"(152)	900	3.10(88)	90(6.3)	9-7/16"(240)	0.4	3.5 1.6	3/8"	82.0	<2.5	5

# AIR SQUARE SANDER

## Square Sander

### SERIES



#### QB-48012

AIR JITTERBUG SANDER  
NON-VACUUM 2.5mm orbit  
Air inlet : 1/4"

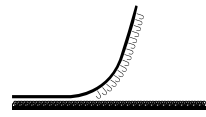

Use with  
VELCRO TYPE  
Sanding Paper



NON-VACUUM



#### QB-48111

AIR JITTERBUG SANDER  
NON-VACUUM 2.5mm orbit  
Air inlet : 1/4"



Sanding paper  
mounted by CLIP



NON-VACUUM



#### QB-48112

AIR JITTERBUG SANDER  
NON-VACUUM 2.5mm orbit  
Air inlet : 1/4"

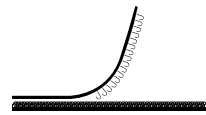

Use with  
VELCRO TYPE  
Sanding Paper



NON-VACUUM



#### QB-48212

AIR JITTERBUG SANDER  
NON-VACUUM 2.5mm orbit  
Air inlet : 1/4"

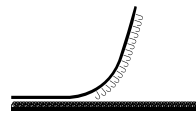

Use with  
VELCRO TYPE  
Sanding Paper



NON-VACUUM



#### QB-48211

AIR JITTERBUG SANDER  
NON-VACUUM 2.5mm orbit  
Air inlet : 1/4"



Sanding paper  
mounted by CLIP



NON-VACUUM

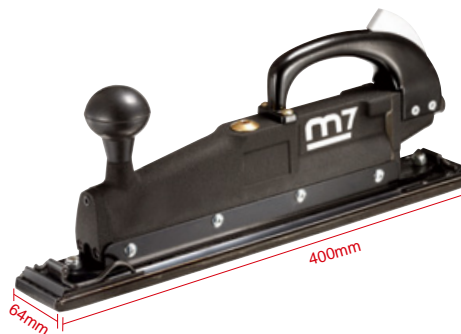

Pad Dia	Free Speed	Avg. Air Consumption	Air Pressure	Overall Length	Motor	Net Weight	Air Hose	Sound Pressure	Vibration Level	orbit	
inch(mm)	R.P.M	CFM (L/min)	PSI (bar)	Inch (mm)	HP	LBS(kg)	Inch	dBA	m/s <sup>2</sup>	mm	
QB-48012	3"x4"(75x100)	10000	5.0(141)	90(6.3)	5-3/8"(137)	0.24	1.83 0.83	3/8"	83.0	1.5	2.5
QB-48111	4"x4-3/8"(100x110)	11000	7.0(198)	90(6.3)	5-1/5"(130)	0.28	2.0 0.91	3/8"	83.0	1.5	2.5
QB-48112	4"x4-3/8"(100x110)	10000	5.0(141)	90(6.3)	5-3/8"(136)	0.24	1.7 0.78	3/8"	83.0	1.5	2.5
QB-48211	2-1/2"x15-3/4"(64x400)	2100	5.0(141)	90(6.3)	17-1/2"(444)	0.24	6.1 2.8	3/8"	83.0	1.5	2.5
QB-48212	7"x3-1/2"(93x180)	10000	5.0(141)	90(6.3)	7"(180)	0.24	2.0 0.94	3/8"	83.0	1.5	2.5





### QP-113

AIR PISTOL SANDER

2.5mm orbit Air inlet : 1/4"



### QP-123

AIR PISTOL POLISHER

Air inlet : 1/4"



### QP-123QP

- Air Pistol Sander, 3" Pad Dia
- QP-113 :Air Pistol Sander, 3" Pad Dia
- QP-123 :Air Pistol Polisher, 3" Pad Dia
- 1/4" Air Adaptor Couplings Male Thread Type
- 3" Sponge (Rough) & 3" Sponge (Medium)



### QP-215

AIR HIGH SPEED SANDER

Air inlet : 1/4"



### QP-317

AIR ANGLE POLISHER

Air inlet : 1/4"



### QP-307 M/S QP-327 M/S

AIR ANGLE POLISHER

Air inlet : 1/4"



### QP-335

VERTICAL POLISHER

Air inlet : 1/4"



	Pad Dia	Spindle Size	Free Speed	Avg. Air Consumption	Air Pressure	Overall Length	Motor	Net Weight		Air Hose	Sound Pressure	Vibration Level	orbit
	inch(mm)		R.P.M	CFM (L/min)	PSI (bar)	Inch (mm)	HP	LBS(kg)		Inch	dBA	m/s <sup>2</sup>	mm
QP-113	3"(76)	5/16"-24	15000	3.5(99)	90(6.3)	5"(127)	0.40	1.5	0.72	3/8"	74.0	0.3	2.5
QP-123	3"(76)	5/16"-24	2100	3.5(99)	90(6.3)	5-5/16"(135)	0.40	1.69	0.77	3/8"	74.0	0.21	---
QP-215	5"(127)	7/16"-20	16000	6.5(184)	90(6.3)	6-19/64"(160)	0.80	2.6	1.20	3/8"	60.0	1.8	---
QP-317	7"(178)	5/8"-11	2500	6.0(169)	90(6.3)	16"(406)	0.40	4.0	2.04	3/8"	84.0	2.5	---
QP-307M	7"(178)	M14xP2	4500	6.0(169)	90(6.3)	16"(406)	0.40	4.0	2.04	3/8"	84.0	2.5	---
QP-307S	7"(178)	5/8"-11	4500	6.0(169)	90(6.3)	16"(406)	0.40	4.0	2.04	3/8"	84.0	2.5	---
QP-327M	7"(178)	M14xP2	2500	6.0(169)	90(6.3)	16"(406)	0.40	4.0	2.04	3/8"	84.0	2.5	---
QP-327S	7"(178)	5/8"-11	2500	6.0(169)	90(6.3)	16"(406)	0.40	4.0	2.04	3/8"	84.0	2.5	---
QP-335	5"(127)	5/16"-24	3000	3.65(103)	90(6.3)	8"(203)	0.55	1.12	0.53	3/8"	85.0	2.5	---

## Air chamfering tools

### QC-512

MINI AIR CHAMFERING TOOLS

Extreme small size and light weight air tool.  
Also have variable chamfering speed function



Triangle Indexable Inserts



	Chamfering Capacity	Free Speed	Overall Length	Air Pressure	Avg. Air Consumption	Net Weight		Air Hose	Sound Pressure
		R.P.M	inch(mm)	PSI (bar)	CFM	LBS	kg	Inch	dBA
QC-512	C0.1 - C2.0	28000	4-1/7"(105)	90 (6.3)	2	1.1	0.5	3/8"	85

# AIR CUTTING TOOLS

AIR CUTTING TOOLS



## QD-242

### AIR FILE WITH HOSE

Air inlet : 1/4"

Note : The air mini saw is not supplied along with the tool

- 5pcs 5.0mm file set included



Air Mini Saw Can Also Be Installed



## QD-221

### AIR SAW WITH HOSE

Air inlet : 1/4"

- 5pcs 4.0mm file set included
- 1pc 32T saw blade included



## QD-230

### AIR MINI SAW WITH HOSE

Air inlet : 1/4"

- 4pcs 5.0mm file set included
- 1pc 32T saw blade included



	Strokes Length mm	Strokes Per min. S.P.M	Collet Size mm	Avg. Air Consumption CFM (L/min)	Air Pressure PSI (bar)	Overall Length Inch (mm)	Net Weight LBS kg	Air Hose Inch	Sound Pressure dBA	Vibration Level m/s <sup>2</sup>
		S.P.M								
QD-221	10	5000	4.0	4.0 (113)	90(6.3)	9-3/4"(250)	1.76 0.8	3/8"	81.9	4.1
QD-230	5	7000	5.0	2.5 (70)	90(6.3)	7"(180)	1.10 0.5	3/8"	78.0	2.4
QD-242	5	7000	5.0	5.3 (150)	90(6.3)	17-9/16"(700)	1.28 0.58	3/8"	80.0	4.5



## QD-260

### AIR MINI SAW / FILE

Air inlet : 1/4"

Note : The package contains a flat file and two saw blades

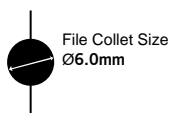

## QD-501

### GEAR DRIVEN AIR SAW (3 in 1)

Air inlet : 1/4"

Note : The File is not supplied along with the tool



### GEAR DRIVING



File

Sawzall Blade

Air Saw



**3 functions in one tool**

	Strokes Length mm	Strokes Per min. S.P.M	Avg. Air Consumption CFM (L/min)	Air Pressure PSI (bar)	Overall Length Inch (mm)	Net Weight LBS kg	Air Hose Inch	Sound Pressure dBA	Vibration Level m/s <sup>2</sup>
		S.P.M							
QD-260	8	7000	4.5 (127)	90 (6.3)	6-11/16" (170)	1 0.5	3/8"	-----	-----
QD-501	10	7000	4.5(127)	90(6.3)	11-5/8"(296)	2.6 1.2	3/8"	78	4.5

★★  **QC-213**

**3" HEAVY DUTY AIR CUT-OFF TOOL**

Available Dimension of inner hold : Ø 3/8"  
Air inlet : 1/4"

Note: wheel is supplied with the tool



★★  **QC-213T**

**3" HEAVY DUTY AIR CUT-OFF TOOL**

Available Dimension of inner hold : Ø 3/8"  
Air inlet : 1/4"

Note: wheel is supplied with the tool



★★  **QC-234**

**4" HEAVY DUTY AIR CUT-OFF TOOL**

Available Dimension of inner hold : Ø 10mm  
Air inlet : 1/4"



★★  **QC-234T**

**4" AIR CORNER CUT-OFF TOOL**

Available Dimension of inner hold : Ø 10mm Ø 16mm  
Air inlet : 1/4"

**Stylized grip**



★★  **QC-264**

**4" AIR CORNER CUT-OFF TOOL**

Available Dimension of inner hold : Ø 10mm Ø 16mm  
Air inlet : 1/4"

**Stylized grip**



★★  **QC-253**

**3" AIR CUT-OFF TOOL**

Air inlet : 1/4"













★★  **QC-254**

**4" AIR CORNER CUT-OFF TOOL**

Available Dimension of inner hold : Ø 10mm  
Air inlet : 1/4"



	Belt Size Pad Dia inch(mm)	Free Speed R.P.M	Avg. Air Consumption CFM (L/min)	Air Pressure PSI (bar)	Overall Length Inch (mm)	Motor HP	Net Weight LBS kg		Air Hose Inch	Sound Pressure dBA	Vibration Level m/s²
											
QC-213	3"(75)	20000	10.0(283)	90(6.3)	7-7/8"(200)	0.9	1.9	0.86	3/8"	80.2	10.8
QC-213T	3"(75)	22000	5.0(141)	90(6.3)	7-7/8"(200)	0.5	1.8	0.82	3/8"	85.0	3.0
QC-234	4"(100)	16000	10.0(283)	90(6.3)	14"(355)	0.9	3.5	1.59	3/8"	85.0	5.0
QC-234T	4"(100)	15000	5.0(141)	90(6.3)	13-9/16"(345)	0.5	3.1	1.41	3/8"	85.0	2.2
QC-253	3"(75)	24000	4.0(113)	90(6.3)	8"(203)	0.6	1.7	0.8	3/8"	91.0	1.2
QC-254	4"(100)	20000	5.0(141)	90(6.3)	8-1/8"(206)	0.6	2.0	0.9	3/8"	81.0	0.8
QC-264	4"(100)	15000	5.0(141)	90(6.3)	9-5/32"(232)	0.5	2.4	1.1	3/8"	85.0	2.2

# AIR CUTTING TOOLS

AIR CUTTING TOOLS

## ★★★ **QK-131**

**Air Oscillating Tool With Universal Adapter**  
Air inlet : 1/4"



Note: Blade is not supplied along with the tool



Patented flange can share pneumatic scraper & electric grinder blade.

## ★★★ **QK-111**

**AIR KNIFE**  
Air inlet : 1/4"



QK-111P51 QK-111P52 QK-111P53



QK-2090 QK-2063 QK-2036



QK-111P08 QK-111P54 QK-111P50



## ★★★ **QK-111T**

**AIR KNIFE**  
Air inlet : 1/4"



**Stylized grip**

## ★★★ **QK-121**

**AIR KNIFE**  
Air inlet : 1/4"



QB-9320



	Oscillation per min	Avg. Air Consumption CFM (L/min)	Overall Length Inch (mm)	Net Weight LBS(kg)	Air Hose Inch	Sound Pressure dBA	Vibration Level m/s <sup>2</sup>
QK-131	20000	1.9(121)	7-1/8"(176)	1.5(0.6)	3/8"	78	4.5
QK-111	20000	6.0(170)	7-5/64" (180)	2.4(1.1)	3/8"	75	3.9
QK-111T	20000	5.0(141)	8-3/16" (208)	2.0(0.92)	3/8"	85	3.3
QK-121	19000	4.3(121)	6-15/16" (208)	1.3(0.6)	3/8"	91	2.8

## ★★★ **QC-333**

Air inlet : 1/4"  
**FLEX-HEAD AIR CUT-OFF TOOL**

Note: wheel is supplied with the tool

**3" wheel**



**3 Angle Adjustable**

	Pad Dia inch(mm)	Free Speed R.P.M	Avg. Air Consumption CFM (L/min)	Air Pressure PSI (bar)	Overall Length Inch (mm)	Motor HP	Net Weight LBS kg	Air Hose Inch	Sound Pressure dBA	Vibration Level m/s <sup>2</sup>
QC-333	3"	20000	3.6(102)	90 (6.3)	9-1/16"(230)	-----	2.42 1.1	3/8"	-----	-----





**PN-150**  
**PN-180**

**AIR PUNCH & FLANGE TOOL**  
Air inlet : 1/4"



**PN-250**  
**PN-280**

**AIR PUNCH & FLANGE TOOL**  
Air inlet : 1/4"



**QK-112**  
**QK-112N** Contains Blade

**AIR SCRAPER KIT**  
Air inlet : 1/4"



**QK-112**



- QK-112N**  
**Blades included:**
1. 1.77" Wide Blade
  2. 1.75" L-Shaped Blade
  3. 1" Wide 45° Blade
  4. 1" Wide Blade

	Punch Diameter	Capacity	Avg. Air Consumption	Air Pressure	Overall Length	Net Weight		Air Hose	Sound Pressure	Vibration Level
	mm		CFM (L/min)	PSI (bar)	Inch (mm)	LBS	kg	Inch	dBA	m/s <sup>2</sup>
PN-150	5	1.6 mm (Steel)	4.0(113)	90(6.3)	10"(254)	2.5	1.15	3/8"	62.0	0.1
PN-180	8	1.2 mm (Steel)	4.0(113)	90(6.3)	10"(254)	2.5	1.15	3/8"	62.0	0.1
PN-250	5	1.6 mm (Steel)	4.0(113)	90(6.3)	7-15/32"(190)	2.6	1.2	3/8"	62.0	0.1
PN-280	8	1.2 mm (Steel)	4.0(113)	90(6.3)	7-15/32"(190)	2.6	1.2	3/8"	62.0	0.1

	Strokes Length	Strokes Per min.	Avg. Air Consumption	Air Pressure	Overall Length	Net Weight		Air Hose	Sound Pressure	Vibration Level
	mm	S.P.M	CFM (L/min)	PSI (bar)	Inch (mm)	LBS	kg	Inch	dBA	m/s <sup>2</sup>
QK-112	16	4200	3.0 (84.9)	90(6.3)	7-23/32"(196)	1.52	0.69	3/8"	93.0	9.0



**QG-102**  
**AIR SHEAR / Straight Type**  
Air inlet : 1/4"



**QG-202**  
**AIR SHEAR / Pistol Type**  
Air inlet : 1/4"



**QG-103**  
**AIR NIBBLER**  
Air inlet : 1/4"



	Strokes Per min	Avg. Air Consumption	Air Pressure	Overall Length	Net Weight		Air Hose	Sound Pressure	Vibration Level	Cut Capacity	
	S.P.M	CFM (L/min)	PSI (bar)	Inch (mm)	LBS	kg	Inch	dBA	m/s <sup>2</sup>	steel	aluminum
QG-102	2600	6.0(170)	90(6.3)	10"(254)	2.2	1.00	3/8"	85.8	2.4	1.2	1.6
QG-202	2600	6.5(184)	90(6.3)	8-1/4"(210)	2.4	1.10	3/8"	89.1	2.9	1.2	1.6
QG-103	2600	3.0 (85)	90(6.3)	7-3/5"(193)	2.2	1.00	3/8"	88.0	2.8	1.2	1.6

# AIR CUTTING TOOLS



## QD-321

**LOW VIBRATION AIR BODY SAW**  
Air inlet : 1/4"



## QD-291N

**AIR SAW SET**  
Air inlet : 1/4"

### Contents

- Air saw tool (1 pcs)
- 24T Saw Blade (6 pcs)
- 32T Saw Blade (6 pcs)
- Allen Key:4mm,3mm (1pcs)
- 1/4" 360° plug
- 5 Pieces file set
- Mini oiler 1/4" (1 pcs)



	Strokes Length mm	Strokes Per min. S.P.M	Collef Size mm	Avg. Air Consumption CFM (L/min)	Air Pressure PSI (bar)	Overall Length Inch (mm)	Net Weight LBS kg	Air Hose Inch	Sound Pressure dBA	Vibration Level m/s <sup>2</sup>
		S.P.M								
QD-291	10	9000	5.0	4.0 (113)	90(6.3)	9-1/4"(235)	1.30 0.6	3/8"	80.0	2.4
QD-321	14.5	11000	5.0	4.0 (113)	90(6.3)	9-1/4"(230)	1.7 0.6	3/8"	83.0	2.0

## Air Drill



## PC-2010

**ADJUSTABLE TORQUE AIR TAPPING TOOL**  
Air inlet : 1/4"



## QE-831

**3/8" AIR REVERSIBLE DRILL WITH KEYLESS CHUCK**  
Air inlet : 1/4"



3pcs Planet Gear



	Capacity			Stall Torque	Free Speed	Stroke Length	Avg. Air Consumption	Air Pressure	Net Weight	Air Hose	Sound Pressure	Vibration Level
	steel	copper	aluminum	N.m	R.P.M	inch( mm )	L/cycle	PSI (bar)	LBS kg	Inch	dBA	m/s <sup>2</sup>
PC-2010	M3-M8	M3-M12	M3-M12	-----	150	12"(305)	6.5(184)	90(6.3)	5.4 2.45	3/8"	82	1.5

	Chuck Size	Free Speed	Motor	Stall Torque	Avg. Air Consumption	Air Pressure	Overall Length	Net Weight	Air Hose	Sound Pressure	Vibration Level
	inch(mm)	R.P.M	hp		CFM (L/min)	PSI (bar)	Inch (mm)	LBS kg	Inch	dBA	m/s <sup>2</sup>
QE-831	3/8"(10)	1800	0.45	7.33	4.0(113)	90(6.3)	7-1/4"(185)	2.5 1.10	3/8"	83.0	0.3



## 3/8" QE-2130/QE-2133/QE-2137 1/2" QE-2143

3/8" Air Reversible Drill

Air inlet : 1/4"

- 4 Running speeds identified by different colour rings for multiple applications.



QE-2130



QE-2143



QE-2137



QE-2133

	Chuck Size inch(mm)	Free Speed R.P.M	Motor hp	Avg. Air Consumption CFM (L/min)	Air Pressure PSI (bar)	Overall Length Inch (mm)	Net Weight LBS / kg	Air Hose Inch	Sound Pressure dBA	Vibration Level m/s <sup>2</sup>
QE-2130	3/8"(10)	3500	0.5(372w)	4(113)	90(6.3)	7.12( 181)	1.76(0.8)	3/8"	92	0.2
QE-2133	3/8"(10)	2000	0.5(372w)	4(113)	90(6.3)	7.12( 181)	1.76(0.8)	3/8"	92	0.2
QE-2137	3/8"(10)	2800	0.5(372w)	4(113)	90(6.3)	7.12( 181)	1.76(0.8)	3/8"	92	0.2
QE-2143	1/2"(13)	500	0.5(372w)	4(113)	90(6.3)	9(229)	2.64(1.2)	3/8"	92	0.2

## PC-901

ADJUSTABLE TORQUE  
AIR TAPPING ADAPTER

HEX:8mm

For: Air Drill, Electricity Drill, Cordless Drill, Drill machine



	CAPACITY		
	steel	copper	aluminum
PC-2010	M3~M8	M3~M12	M3~M12
PC-901	M3~M6	M3~M8	M3~M8



## QE-231

SPOT DRILL & HOOK

Air inlet : 1/4"

- 8 mm drill bit included
- 6.5,8,10 mm drill are available
- Adjustable chuck for easy control
- Hook is easily removed or installed.
- High quality piston improves torque and efficiency
- Common applications are remove the surface of the solder joints and will not damage steel plate.
- Maximum drill depth: 4.5 mm, steel: 3.8 mm stainless



	Chuck Size inch(mm)	Free Speed R.P.M	Motor hp	Stall Torque N.m	Overall Length inch (mm)	Avg. Air Consumption CFM (L/min)	Air Pressure PSI (bar)	Net Weight LBS kg	Air Hose Inch	Sound Pressure dBA	Vibration Level m/s <sup>2</sup>
QE-231	5/16"(8)	1600	0.50	12.36	6.0(170)	90(6.3)	9-1/4"(235)	4.4 2.0	3/8"	88.2	0.1

# AIR DRILL

**3/8" Chuck Size**



## QE-331/332

QE-331 3/8" AIR REVERSIBLE DRILL  
QE-332 3/8" AIR DRILL

With Keyless Chuck Air inlet : 1/4"



3pcs Planet Gear



## QE-333/334

QE-333 3/8" AIR REVERSIBLE DRILL  
QE-334 3/8" AIR DRILL

With Key Chuck Air inlet : 1/4"



3pcs Planet Gear



## QE-431/432

QE-431 3/8" AIR REVERSIBLE DRILL  
QE-432 3/8" AIR DRILL

With Keyless Chuck Air inlet : 1/4"



2pcs Planet Gear with bearing



## QE-433/434

QE-433 3/8" AIR REVERSIBLE DRILL  
QE-434 3/8" AIR DRILL

With Key Chuck Air inlet : 1/4"



2pcs Planet Gear with bearing



## QE-532

3/8" AIR DRILL  
With Keyless Chuck Air inlet : 1/4"



3pcs Planet Gear with bearing



## QE-533

3/8" AIR REVERSIBLE DRILL  
With Key Chuck Air inlet : 1/4"



3pcs Planet Gear with bearing



## QE-833

3/8" AIR REVERSIBLE DRILL  
With Key Chuck Air inlet : 1/4"



3pcs Planet Gear



## QE-633

3/8" 90° AIR REVERSIBLE DRILL  
With Keyless Chuck Air inlet : 1/4"



2pcs Planet Gear with bearing



## QE-933

3/8" AIR REVERSIBLE DRILL  
With Keyless Chuck Air inlet : 1/4"



2pcs Planet Gear with bearing



## QE-935

3/8" AIR STRAIGHT DRILL  
With Keyless Chuck Air inlet : 1/4"

**Stylized grip**



2pcs Planet Gear with bearing



## QE-936

3/8" AIR STRAIGHT DRILL  
WITH KEY CHUCK Air inlet : 1/4"

**Stylized grip**





	Chuck Size inch(mm)	Free Speed R.P.M	Motor hp	Stall Torque N.m	Avg. Air Consumption CFM (L/min)	Air Pressure PSI (bar)	Overall Length Inch (mm)	Net Weight LBS kg		Air Hose Inch	Sound Pressure dBA	Vibration Level m/s <sup>2</sup>
QE-331	3/8"(10)	1800	0.65	6.29	6.5(184)	90(6.3)	8"(203)	2.42	1.1	3/8"	96.5	0.3
QE-332	3/8"(10)	2200	0.60	6.31	6.5(184)	90(6.3)	7-1/2"(190)	2.20	1.0	3/8"	96.5	0.3
QE-333	3/8"(10)	1800	0.65	6.29	6.5(184)	90(6.3)	8"(203)	2.42	1.1	3/8"	92.0	0.2
QE-334	3/8"(10)	2200	0.60	6.31	6.5(184)	90(6.3)	7-1/2"(190)	2.20	1.0	3/8"	92.0	0.2
QE-431	3/8"(10)	1800	0.50	10.9	4.0(112)	90(6.3)	8-29/32"(226)	2.6	1.18	3/8"	90.0	3.0
QE-432	3/8"(10)	2200	0.70	8.76	4.8(135)	90(6.3)	8-29/32"(226)	2.6	1.18	3/8"	90.0	3.0
QE-433	3/8"(10)	1800	0.50	10.9	4.0(112)	90(6.3)	9-1/16"(230)	2.7	1.23	3/8"	90.0	3.0
QE-434	3/8"(10)	2200	0.70	8.76	4.8(135)	90(6.3)	9-1/16"(230)	2.7	1.23	3/8"	90.0	3.0
QE-532	3/8"(10)	2800	0.70	8.58	4.8(135)	90(6.3)	9-9/16"(243)	2.7	1.23	3/8"	90.0	3.0
QE-533	3/8"(10)	2200	0.50	10.58	4.0(112)	90(6.3)	9-13/32"(189)	2.7	1.23	3/8"	90.0	3.0
QE-833	3/8"(10)	1800	0.45	7.33	4.0(113)	90(6.3)	7-1/4"(185)	2.7	1.23	3/8"	83.0	0.3
QE-633	3/8"(10)	1600	0.50	6.06	3.0(85)	90(6.3)	8-1/4"(210)	2.4	1.10	3/8"	72.0	2.5
QE-933	3/8"(10)	2600	0.50	3.85	3.0(85)	90(6.3)	8-15/32"(215)	2.0	0.90	3/8"	72.0	2.5
QE-935	3/8"(10)	4000	0.5	2.98	5.0(141)	90(6.3)	9"(230)	1.89	0.86	3/8"	85.0	1.6
QE-936	3/8"(10)	22000	0.5	-----	5.0(141)	90(6.3)	8-9/16"(218)	1.62	0.74	3/8"	85.0	1.2

# 1/2" Chuck Size



## QE-341/342

QE-341 1/2" Air Reversible Drill  
QE-342 1/2" Air Drill  
With Keyless Chuck Air inlet : 1/4"



3pcs Planet Gear x 2Set



## QE-343/344

QE-343 1/2" Air Reversible Drill  
QE-344 1/2" Air Drill  
With Key Chuck Air inlet : 1/4"



3pcs Planet Gear x 2Set



## QE-441/442

QE-441 1/2" Air Reversible Drill  
QE-442 1/2" Air Drill  
With Keyless Chuck Air inlet : 1/4"



2pcs Planet Gear x 2Set bearing



## QE-443

1/2" Air Reversible Drill  
With Key Chuck  
Air inlet : 1/4"



2pcs Planet Gear x 2Set bearing



## QE-542

1/2" Air Drill  
With Keyless Chuck Air inlet : 1/4"



3pcs Planet Gear x 2Set bearing



## QE-543

1/2" Air Reversible Drill  
With Key Chuck Air inlet : 1/4"



3pcs Planet Gear x 2Set bearing

# AIR DRILL



## QE-841

1/2" Air Reversible Drill  
With Keyless Chuck Air inlet : 1/4"



3pcs Planet Gear x 2Set



## QE-843

1/2" Air Reversible Drill  
With Key Chuck Air inlet : 1/4"



3pcs Planet Gear x 2Set



## QE-845

1/2" Air Reversible Drill  
With Key Chuck Air inlet : 1/4"



3pcs Planet Gear x 2Set

	Chuck Size inch(mm)	Free Speed R.P.M	Motor hp	Stall Torque N.m	Avg. Air Consumption CFM (L/min)	Air Pressure PSI (bar)	Overall Length Inch (mm)	Net Weight LBS kg		Air Hose Inch	Sound Pressure dBA	Vibration Level m/s <sup>2</sup>
QE-341	1/2"(13)	800	0.65	11.15	6.5(184)	90(6.3)	9"(230)	3.96	1.8	3/8"	96.5	0.1
QE-342	1/2"(13)	800	0.60	11.03	6.5(184)	90(6.3)	8-1/4"(209)	3.74	1.7	3/8"	96.5	0.1
QE-343	1/2"(13)	800	0.65	11.15	6.5(184)	90(6.3)	9"(230)	3.96	1.8	3/8"	97.5	0.1
QE-344	1/2"(13)	800	0.60	11.03	6.5(184)	90(6.3)	8-1/4"(209)	3.74	1.7	3/8"	97.5	0.1
QE-441	1/2"(13)	1100	0.50	14.68	4.0(112)	90(6.3)	10-5/8"(270)	3.5	1.58	3/8"	90.0	3.0
QE-442	1/2"(13)	1300	0.70	13.54	4.8(135)	90(6.3)	10-5/8"(270)	3.5	1.58	3/8"	90.0	3.0
QE-443	1/2"(13)	1100	0.50	14.68	4.0(112)	90(6.3)	10-5/8"(270)	3.8	1.73	3/8"	90.0	3.0
QE-542	1/2"(13)	1300	0.70	15.89	4.8(135)	90(6.3)	11"(280)	3.8	1.73	3/8"	90.0	3.0
QE-543	1/2"(13)	1100	0.50	14.89	4.0(112)	90(6.3)	10-7/8"(276)	3.8	1.73	3/8"	90.0	3.0
QE-841	1/2"(13)	800	0.45	12.58	4.0(113)	90(6.3)	8-1/4"(210)	3.7	1.7	3/8"	83.0	0.3
QE-843	1/2"(13)	800	0.45	12.58	4.0(113)	90(6.3)	8-1/4"(210)	3.9	1.8	3/8"	83.0	0.3
QE-845	1/2"(13)	500	0.45	12.83	4.0(113)	90(6.3)	8-1/4"(210)	3.9	1.8	3/8"	83.0	0.3

## NEW PRODUCT



## QE-6030 QE-6030L

Air Right Angle Drill / Threaded type  
Air inlet : 1/4"



## QE-6130 QE-6130L

Air Right Angle Drill / Threaded type  
Air inlet : 1/4"





## QE-6010 QE-6010L

Air 45° Angle Drill / Threaded type  
Air inlet : 1/4"



## QE-6020 QE-6020L

Air Right Angle Drill / Threaded type  
Air inlet : 1/4"



## QE-6120 QE-6120L

Air Right Angle Drill / Threaded type  
Air inlet : 1/4"



## QE-6110 QE-6110L

Air 45° Angle Drill / Threaded type  
Air inlet : 1/4"



## QE-6021 QE-6021L

Air Right Angle Drill / Collect type  
Air inlet : 1/4"



## QE-6011 QE-6011L

Air 45° Angle Drill / Collect type  
Air inlet : 1/4"



# AIR DRILL



## QE-6121 QE-6121L

Air Right Angle Drill / Collect type  
Air inlet : 1/4"



## QE-6111 QE-6111L

Air 45° Angle Drill / Collect type  
Air inlet : 1/4"



	Spindle Size	Free Speed	Motor	Air Inlet	Overall Length	Avg. Air Consumption	Air Pressure	Net Weight		Air Hose	Sound Pressure	Vibration Level
		R.P.M	hp	kg/cm <sup>2</sup>	inch ( mm )	CFM (L/min)	PSI (bar)	LBS	kg	Inch	dBA	m/s <sup>2</sup>
QE-6030	1/4"-28	4000	0.40	1/4"	9-1/2"(240)	3.0(84)	90(6.3)	1.4	0.64	3/8"	81.5	<2.5
QE-6030L	1/4"-28	4000	0.40	1/4"	12-1/8"(308)	3.0(84)	90(6.3)	1.65	0.75	3/8"	81.5	<2.5
QE-6020	1/4"-28	4000	0.40	1/4"	9-1/2"(240)	3.0(84)	90(6.3)	1.4	0.64	3/8"	81.5	<2.5
QE-6020L	1/4"-28	4000	0.40	1/4"	12-1/8"(308)	3.0(84)	90(6.3)	1.65	0.75	3/8"	81.5	<2.5
QE-6010	1/4"-28	4000	0.40	1/4"	10"(256)	3.0(84)	90(6.3)	1.4	0.64	3/8"	81.5	<2.5
QE-6010L	1/4"-28	4000	0.40	1/4"	13-1/8"(333)	3.0(84)	90(6.3)	1.65	0.75	3/8"	81.5	<2.5
QE-6130	1/4"-28	3600	0.60	1/4"	10-1/4"(259)	3.5(99)	90(6.3)	2.2	1.0	3/8"	82	<2.5
QE-6130L	1/4"-28	3600	0.60	1/4"	12-7/8"(327)	3.5(99)	90(6.3)	2.2	1.0	3/8"	82	<2.5
QE-6120	1/4"-28	3600	0.60	1/4"	10-1/4"(259)	3.5(99)	90(6.3)	2.2	1.0	3/8"	82	<2.5
QE-6120L	1/4"-28	3600	0.60	1/4"	12-7/8"(327)	3.5(99)	90(6.3)	2.2	1.0	3/8"	82	<2.5
QE-6110	1/4"-28	3600	0.60	1/4"	10-7/8"(274)	3.5(99)	90(6.3)	1.9	0.86	3/8"	82	<2.5
QE-6110L	1/4"-28	3600	0.60	1/4"	13-7/8"(351)	3.5(99)	90(6.3)	2.2	1.0	3/8"	82	<2.5
QE-6021	9/32"-40	4000	0.40	1/4"	9-1/2"(240)	3.0(84)	90(6.3)	1.4	0.64	3/8"	81.5	<2.5
QE-6021L	9/32"-40	4000	0.40	1/4"	9-1/2"(240)	3.0(84)	90(6.3)	1.65	0.75	3/8"	81.5	<2.5
QE-6011	9/32"-40	4000	0.40	1/4"	10"(256)	3.0(84)	90(6.3)	1.4	0.64	3/8"	81.5	<2.5
QE-6011L	9/32"-40	4000	0.40	1/4"	13-1/8"(333)	3.0(84)	90(6.3)	1.65	0.75	3/8"	81.5	<2.5
QE-6121	9/32"-40	3600	0.60	1/4"	10-1/4"(259)	3.5(99)	90(6.3)	1.9	0.86	3/8"	82	<2.5
QE-6121L	9/32"-40	3600	0.60	1/4"	12-7/8"(327)	3.5(99)	90(6.3)	2.2	1.0	3/8"	82	<2.5
QE-6111	9/32"-40	3600	0.60	1/4"	10-7/8"(274)	3.5(99)	90(6.3)	1.9	0.86	3/8"	82	<2.5
QE-6111L	9/32"-40	3600	0.60	1/4"	13-7/8"(351)	3.5(99)	90(6.3)	2.2	1.0	3/8"	82	<2.5





## QE-6022 QE-6022L

Air Right Angle Drill / Chuck type  
Air inlet : 1/4"



## QE-6112 QE-6112L

Air 45°Angle Drill / Chuck type  
Air inlet : 1/4"



## QE-6012 QE-6012L

Air Right Angle Drill / Chuck type  
Air inlet : 1/4"



## QE-6122 QE-6122L

Air Right Angle Drill / Chuck type  
Air inlet : 1/4"



	Chuck Size Inch (mm)	Free Speed R.P.M	Motor hp	Air Inlet kg/cm <sup>2</sup>	Overall Length inch (mm)	Avg. Air Consumption CFM (L/min)	Air Pressure PSI (bar)	Net Weight LBS kg		Air Hose Inch	Sound Pressure dBA	Vibration Level m/s <sup>2</sup>
QE-6022	1/8"(3mm)	4000	0.40	1/4"	9-1/2"(240)	3.0(84)	90(6.3)	1.4	0.64	3/8"	81.5	<2.5
QE-6022L	1/8"(3mm)	4000	0.40	1/4"	12-1/8"(308)	3.0(84)	90(6.3)	1.65	0.75	3/8"	81.5	<2.5
QE-6012	1/8"(3mm)	4000	0.40	1/4"	10-1/8"(256)	3.0(84)	90(6.3)	1.4	0.64	3/8"	81.5	<2.5
QE-6012L	1/8"(3mm)	4000	0.40	1/4"	13-1/8"(333)	3.0(84)	90(6.3)	1.65	0.75	3/8"	81.5	<2.5
QE-6122	1/8"(3mm)	3600	0.60	1/4"	10-1/4"(259)	3.5(99)	90(6.3)	1.9	0.86	3/8"	82	<2.5
QE-6122L	1/8"(3mm)	3600	0.60	1/4"	12-7/8"(327)	3.5(99)	90(6.3)	2.2	1.0	3/8"	82	<2.5
QE-6112	1/8"(3mm)	3600	0.60	1/4"	10-3/4"(274)	3.5(99)	90(6.3)	1.9	0.86	3/8"	82	<2.5
QE-6112L	1/8"(3mm)	3600	0.60	1/4"	13-7/8"(351)	3.5(99)	90(6.3)	2.2	1.0	3/8"	82	<2.5

# AIR SCREWDRIVER



Pistol Type

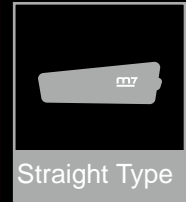

Straight Type

★★  
Excellent

★  
Good

AIR SCREWDRIVER

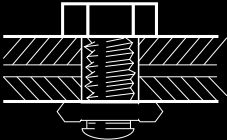
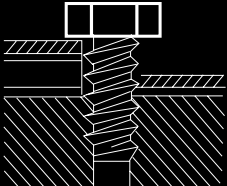
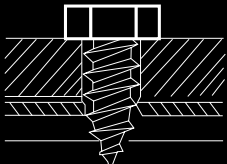
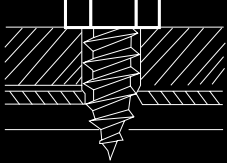
Joint & Torque Curve	Clutch Type	Model Number							
		M3	M3.5	M4	M5	M6	M8		
 <p>Free Running Hard stop/soft stop</p>	★★ Shut-off Screwdriver	RA-3023	RA-3017	RA-3011	RA-4008				
			RA-3123	RA-4015	RA-5005				
				RA-4021	RA-5008				
				RA-5017	RA-4108				
				RA-3111	RA-4115				
			RA-3117	RA-5015					
			RA-4121	RA-5108					
				RA-5117					
		★ Adjustable Clutch			RA-1131	RA-1151	RA-802		
					RA-1132	RA-2161	RA-302		
				RA-1141					
				RA-1142					
				RA-1162					
 <p>Self-Tapping Thick Material Sheet Metal</p>	★★ Adjustable Clutch			RA-1131	RA-1151	RA-802			
					RA-1132	RA-2161	RA-302		
					RA-1141				
					RA-1142				
					RA-1162				
		★ Twin Dog & Twin Hammer			RA-301				
					RA-801				
					RA-1232	RA-2242	RA-606	RA-2272	
					RA-1242	RA-102	RA-201	RA-608	
					RA-101		RA-110	RA-1272	
 <p>Self-Tapping Plastic</p>	★★ Adjustable Clutch			RA-101C		RA-105	RA-111		
					RA-1131	RA-1151	RA-802		
					RA-1132	RA-2161	RA-302		
					RA-1141				
					RA-1142				
		★ Twin Dog			RA-1162				
					RA-301				
					RA-801				
					RA-1232	RA-2242	RA-606	RA-2272	
					RA-1242	RA-102	RA-201	RA-608	
 <p>Wood screws</p>	★★ Positive Clutch			RA-101		RA-105	RA-1272		
					RA-101C				
		★ Twin Dog					RA-811		
							RA-402		
						RA-1232	RA-2242	RA-606	RA-2272
						RA-1242	RA-102	RA-201	RA-608

# Clutch Type Series

Extmal Adjustment

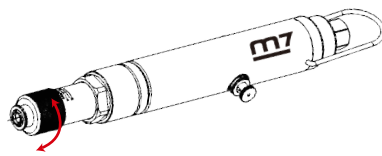

## RA-1131

**AIR SCREWDRIVER ADJUSTABLE CLUTCH**

Screw Capacity : M4  
Air inlet : 1/4"

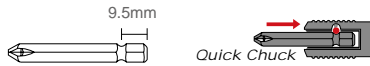

## RA-1141

**AIR SCREWDRIVER ADJUSTABLE CLUTCH**

Screw Capacity : M4  
Air inlet : 1/4"



## RA-1151

**AIR SCREWDRIVER ADJUSTABLE CLUTCH**

Screw Capacity : M5  
Air inlet : 1/4"

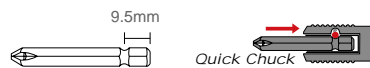

## RA-2161

**AIR SCREWDRIVER ADJUSTABLE CLUTCH**

Screw Capacity : M5  
Air inlet : 1/4"



# Impact Type Series



## RA-101 RA-101C

**Twin Dog Type**

Screw Capacity : M4  
Air inlet : 1/4"



## RA-102

**Twin Dog Type**

Screw Capacity : M5  
Air inlet : 1/4"



## RA-105

**Twin Dog Type**

Screw Capacity : M6  
Air inlet : 1/4"

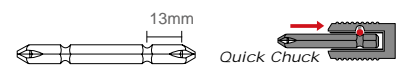

## RA-110

**Twin Hammer Type**

Screw Capacity : M6  
Air inlet : 1/4"

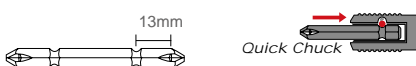

## RA-1232

**Twin Dog Type**

Screw Capacity : M4  
Air inlet : 1/4"

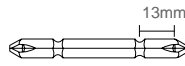

## RA-1242

**Twin Dog Type**

Screw Capacity : M4  
Air inlet : 1/4"

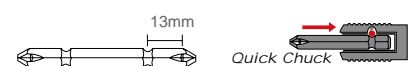

# AIR SCREWDRIVER

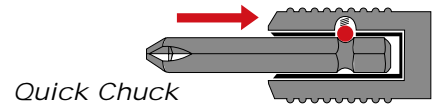

## RA-1272

**Twin Dog Type**  
Screw Capacity : M8  
Air inlet : 1/4"

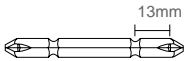

## RA-608

**Twin Dog Type**  
Screw Capacity : M8  
Air inlet : 1/4"

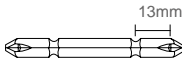

## RA-201

**Twin Dog Type**  
Screw Capacity : M8  
Air inlet : 1/4"



## RA-606

**Twin Dog Type**  
Screw Capacity : M6  
Air inlet : 1/4"

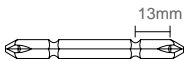

## RA-2242

**Twin Dog Type**  
Screw Capacity : M5  
Air inlet : 1/4"

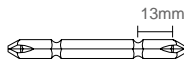

## RA-2272

**Twin Dog Type**  
Screw Capacity : M8  
Air inlet : 1/4"

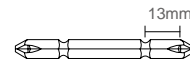

	Bit Size inch(mm)	Torque Range FT-LB(Nm)	Free Speed R.P.M	Avg. Air Consumption Pressure CFM (L/min)	Air Pressure PSI (bar)	Overall Length Inch (mm)	Net Weight LBS kg		Air Hose Inch	Sound Pressure dBA	Vibration Level m/s <sup>2</sup>
RA-1131	1/4"(6.35)	0.7-2.9(1-4)	1800	4.5(127)	90(6.3)	9"(228)	1.6	0.76	3/8"	80.0	2.3
RA-1141	1/4"(6.35)	0.7-2.2(1-3)	800	4.5(127)	90(6.3)	8-7/8"(226)	1.6	0.76	3/8"	80.0	2.3
RA-1151	1/4"(6.35)	1.4-3.7(2-5)	1900	4.5(127)	90(6.3)	9-1/32"(229)	2.2	1.01	3/8"	85.0	2.3
RA-2161	1/4"(6.35)	1.4-3.7(2-5)	750	7.5(212)	90(6.3)	7-15/32"(190)	2.0	1.00	3/8"	80.0	2.0
RA-101	1/4"(6.35)	3.7-8.9(5-12)	9000	6.0(170)	90(6.3)	6-1/2"(166)	1.32	0.6	3/8"	85.7	2.2
RA-102	1/4"(6.35)	3.7-10.3(5-14)	9000	6.0(170)	90(6.3)	6-3/4"(172)	1.54	0.7	3/8"	86.7	3.7
RA-105	1/4"(6.35)	3.7-16.2(5-22)	8500	8.5(241)	90(6.3)	8-1/4"(208)	2.20	1.0	3/8"	96.7	4.9
RA-110	1/4"(6.35)	3.7-29.5(5-40)	8500	8.5(241)	90(6.3)	8-1/4"(208)	2.20	1.0	3/8"	96.7	4.9
RA-1232	1/4"(6.35)	11-22 (15-30)	9000	4.5(127)	90(6.3)	7-11/16"(195)	1.47	0.67	3/8"	80.0	3.2
RA-1242	1/4"(6.35)	14-22 (19-30)	12500	5.0(141)	90(6.3)	6-11/16"(170)	1.25	0.57	3/8"	89.0	3.9
RA-1272	1/4"(6.35)	44-177(60-240)	8000	9.0(255)	90(6.3)	7-27/32"(200)	2.30	1.06	3/8"	97.0	5.1
RA-201	1/4"(6.35)	3.7-18.5(5-25)	10000	9.0(255)	90(6.3)	7"(180)	2.65	1.2	3/8"	93.0	5.3
RA-606	1/4"(6.35)	3.7-33.2(5-45)	8000	5.6(160)	90(6.3)	7-4/5"(198)	2.2	1.0	3/8"	82.0	2.2
RA-608	1/4"(6.35)	3.7-42.8(5-58)	8000	4.6(130)	90(6.3)	8-9/16"(217)	2.86	1.3	3/8"	86.0	3.5
RA-2242	1/4"(6.35)	18-26(24.4-35.2)	13000	7.0(198)	90(6.3)	5-15/16"(150)	2.0	0.9	3/8"	88.0	2.7
RA-2272	1/4"(6.35)	44-177(59-240)	7700	8.5(240)	90(6.3)	7-11/16"(195)	3.0	1.38	3/8"	93.0	4.9



## Clutch Type Series

Internal Adjustment



**RA-1132**

**ADJUSTABLE CLUTCH**

Screw Capacity : M4  
Air inlet : 1/4"

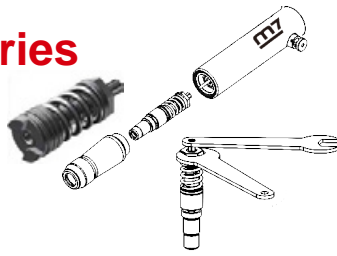
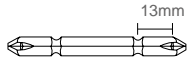

Quick Chuck

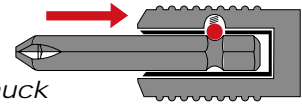

**RA-1142**

**ADJUSTABLE CLUTCH**

Screw Capacity : M4  
Air inlet : 1/4"

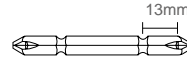

**RA-1162**

**ADJUSTABLE CLUTCH**

Screw Capacity : M6  
Air inlet : 1/4"

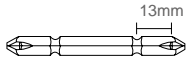

**RA-301**

**ADJUSTABLE CLUTCH**

Screw Capacity : M4  
Air inlet : 1/4"

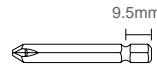

Quick Chuck

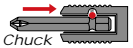

**RA-302**

**ADJUSTABLE CLUTCH**

Screw Capacity : M6  
Air inlet : 1/4"

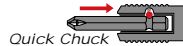
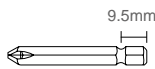

**RA-801**

**ADJUSTABLE CLUTCH**

Screw Capacity : M4  
Air inlet : 1/4"

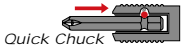
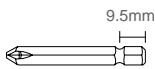

**RA-802**

**ADJUSTABLE CLUTCH**

Screw Capacity : M6  
Air inlet : 1/4"

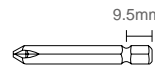

## Positive Clutch Type Non - Adjustable



**RA-402**

**Positive Clutch Type**

Screw Capacity : M6  
Air inlet : 1/4"

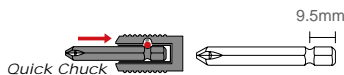

## Torque Control or Shut-off



**RA-31/RA-41/RA-51**

**SERIES**

**SHUT-OFF SCREWDRIVER**

Air inlet : 1/4"

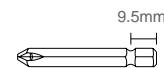
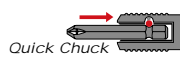

**R**everse



**RA-811**

**Positive Clutch Type**

Screw Capacity : M6  
Air inlet : 1/4"

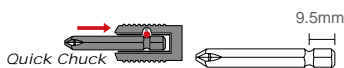

**RA-30/RA-40/RA-50**

**SERIES**

**SHUT-OFF SCREWDRIVER**

Air inlet : 1/4"

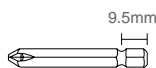
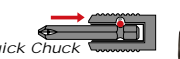

**R**everse



# AIR SCREWDRIVER

**NEW PRODUCT**

## ZT-31

**DIGITAL TORQUE TESTER**  
Torque Range 0~14.7Nm



## RA-801ET

**AIR SCREWDRIVER**  
**EXTERNAL ADJUSTABLE**

Screw Capacity : M4  
Air inlet : 1/4"

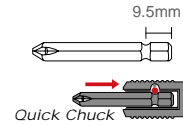

	Bit Size inch(mm)	Torque Range FT-LB(Nm)	Free Speed R.P.M	Avg. Air Consumption CFM (L/min)	Air Pressure PSI (bar)	Overall Length Inch (mm)	Net Weight LBS kg		Air Hose Inch	Sound Pressure dBA	Vibration Level m/s <sup>2</sup>
RA-1132	1/4"(6.35)	0.7~2.2(1-3)	2200	6.0(170)	90(6.3)	9-7/32"(235)	1.7	0.8	3/8"	80.0	2.3
RA-1142	1/4"(6.35)	0.7~2.2(1-3)	1700	5.0(141)	90(6.3)	9-7/32"(235)	1.34	0.61	3/8"	80.0	2.0
RA-1162	1/4"(6.35)	1.5~5.9(2-8)	600	6.0(170)	90(6.3)	10-7/16"(265)	2.1	0.95	3/8"	90.0	2.2
RA-301	1/4"(6.35)	3.8-10(5-13.5)	1800	6.0(170)	90(6.3)	7-1/2"(190)	2.40	1.1	3/8"	95.3	4.2
RA-302	1/4"(6.35)	3.8-12(5-16.3)	800	6.0(170)	90(6.3)	9"(226)	2.87	1.3	3/8"	96.5	2.2
RA-801	1/4"(6.35)	3.8-10.4(5-14)	1800	4.0(113)	90(6.3)	7-3/4"(195)	2.70	1.22	3/8"	83.0	4.2
RA-802	1/4"(6.35)	3.8-13.3(5-18)	800	4.0(113)	90(6.3)	8-9/32"(210)	2.80	1.30	3/8"	83.0	4.2
RA-402	1/4"(6.35)	5-14(6~19)	2200	3.9(111)	90(6.3)	7-3/32"(180)	2.47	1.1	3/8"	91.0	2.3
RA-811	1/4"(6.35)	5.0-13.0(6-17)	2100	4.0(113)	90(6.3)	7"(178)	2.50	1.13	3/8"	83.0	3.7
RA-801ET	1/4"(6.35)	13.2-23(1.5-2.6)	1700	17.5(496)	90(6.3)	7-4/5"(198)	2.65	1.20	1/4"	93.6	1.35

	Bit Size inch(mm)	Torque Range IN-LB(Nm)	Free Speed R.P.M	Avg. Air Consumption CFM (L/min)	Air Pressure PSI (bar)	Overall Length Inch (mm)	Net Weight LBS kg		Air Hose Inch	Sound Pressure dBA	Vibration Level m/s <sup>2</sup>
RA-3011	1/4"(6.35)	9.7-18.6(1.1-2.1)	1100	3.2(90.6)	90(6.3)	7-3/8"(187)	0.94	0.42	1/4"	70.0	2.0
RA-3017	1/4"(6.35)	6.2-13.3(0.7-1.5)	1700	3.2(90.6)	90(6.3)	7-3/8"(187)	0.94	0.42	1/4"	70.0	2.0
RA-3023	1/4"(6.35)	3.5-8.8(0.4-1.0)	2300	3.2(90.6)	90(6.3)	7-3/8"(187)	0.94	0.42	1/4"	70.0	2.0
RA-4008	1/4"(6.35)	14.1-35.4(1.6-4.0)	800	3.7(104.8)	90(6.3)	8-1/4"(209)	1.43	0.65	1/4"	74.0	2.5
RA-4015	1/4"(6.35)	8.8-19.5(1.0-2.2)	1500	3.7(104.8)	90(6.3)	8-1/4"(209)	1.43	0.65	1/4"	74.0	2.5
RA-4021	1/4"(6.35)	8.8-15(1.0-1.7)	2100	3.7(104.8)	90(6.3)	8-1/4"(209)	1.43	0.65	1/4"	74.0	2.5
RA-5005	1/4"(6.35)	44.2-92.9(5.0-10.5)	480	4.0(113)	90(6.3)	9-1/2"(240)	2.2	1.0	3/8"	75.0	10
RA-5008	1/4"(6.35)	26.5-48.7(3.0-5.5)	800	4.0(113)	90(6.3)	9-1/2"(240)	2.2	1.0	3/8"	75.0	10
RA-5017	1/4"(6.35)	13.3-23.0(1.5-2.6)	1700	4.0(113)	90(6.3)	9-1/2"(240)	2.2	1.0	3/8"	75.0	10
RA-3111	7/64"(2.6)	9.7-18.5(1.1-2.1)	1100	7.0(198)	90(6.3)	6-11/16"(170)	1.57	0.71	1/4"	82.0	0.73
RA-3117	1/4"(6.35)	6.2-13.2(0.7-1.5)	1700	7.0(198)	90(6.3)	6-11/16"(170)	1.57	0.71	1/4"	84.0	1.51
RA-3123	1/4"(6.35)	3.5-8.8(0.4-1.0)	2300	7.0(198)	90(6.3)	6-11/16"(170)	1.57	0.71	1/4"	84.0	1.34
RA-4108	1/4"(6.35)	14.1-35.2(1.6-4.0)	800	10.5(297)	90(6.3)	6-15/16"(175)	1.92	0.87	1/4"	87.5	1.18
RA-4115	1/4"(6.35)	8.8-19.4(1.0-2.2)	1500	10.5(297)	90(6.3)	6-15/16"(175)	1.92	0.87	1/4"	85.5	1.59
RA-4121	1/4"(6.35)	8.8-13.2(1.0-1.7)	2100	10.5(297)	90(6.3)	6-15/16"(175)	1.92	0.87	1/4"	86.8	1.61
RA-5105	1/4"(6.35)	44-92.4(5.0-10.5)	480	17.5(496)	90(6.3)	7-4/5"(198)	2.65	1.20	1/4"	93.1	0.48
RA-5108	1/4"(6.35)	26.4-48.4(3.0-5.5)	800	17.5(496)	90(6.3)	7-4/5"(198)	2.65	1.20	1/4"	93.6	0.93
RA-5117	1/4"(6.35)	13.2-23(1.5-2.6)	1700	17.5(496)	90(6.3)	7-4/5"(198)	2.65	1.20	1/4"	93.6	1.35

# SPRING BALANCER

SP-3400  
SP-3500



**SP-101/102**  
**SP-103/104**  
**SP-105/111**  
**SP-112/113**



SP-212  
SP-213



**SP-3600**  
SP-3700  
SP-3900  
SP-31050  
SP-31200



**SP-3050/3070**  
**SP-3090/3150**  
**SP-3220/3300**



	Capacity Kg	Travel m	Rope	Rope Dia mm	Weight kg
SP-3300	22~30	1.3	Cable	4.8	8.3
SP-3400	30~40	1.5	Cable	4.8	9.7
SP-3500	40~50	1.5	Cable	4.8	10.1
SP-3600	50~60	1.5	Cable	4.8	11.1
SP-3700	60~70	1.5	Cable	4.8	11.4
SP-3900	70~90	2	Cable	4.8	22.2
SP-31050	90~105	2	Cable	4.8	23.8
SP-31200	105~120	2	Cable	4.8	27.4

	Capacity Kg	Travel m	Rope	Rope Dia mm	Weight kg
SP-101	0.3~0.8	1.4	Cable	2.5	0.49
SP-102	0.6~1.5	1.4	Cable	2.5	0.52
SP-103	1.0~2.0	1.4	Cable	2.5	0.53
SP-104	1.5~3.0	1.4	Cable	3.2	0.76
SP-105	3.0~5.0	1.4	Cable	3.2	0.81
SP-111	0.3~0.8	1.4	Nylon	4.0	0.49
SP-112	0.6~1.5	1.4	Nylon	4.0	0.52
SP-113	1.0~2.0	1.4	Nylon	4.0	0.53

	Capacity Kg	Travel m	Rope	Rope Dia mm	Weight kg
SP-212	0.3~1.2	1.6	Nylon	4.0	0.57
SP-213	0.8~2.0	1.6	Nylon	4.0	0.57
SP-3050	3.0~5.0	1.3	Cable	3.2	1.82
SP-3070	5.0~7.0	1.3	Cable	3.2	1.85
SP-3090	5.0~9.0	1.3	Cable	4.0	3.59
SP-3150	9.0~15.0	1.3	Cable	4.0	3.61
SP-3220	15.0~22.0	1.3	Cable	4.8	7.7
SP-3300	22.0~30.0	1.3	Cable	4.8	8.3

# AIR HAMMER



SC-331C

AIR HAMMER ROUND SHANK



SC-332C

AIR HAMMER ROUND SHANK



SC-341C

AIR HAMMER HEX SHANK  
LOW VIBRATION AIR HAMMER

Air inlet : 1/4"

SC-4 chisel kit is provided along with the tool.



SC-342C

AIR HAMMER HEX SHANK  
LOW VIBRATION AIR HAMMER

Air inlet : 1/4"

SC-4 chisel kit is provided along with the tool.



SC-211C

AIR HAMMER ROUND SHANK



SC-212C

AIR HAMMER ROUND SHANK



SC-221C

AIR HAMMER HEX SHANK

Air inlet : 1/4"

SC-4 chisel kit is provided along with the tool.



SC-222C

AIR HAMMER HEX SHANK

Air inlet : 1/4"

SC-4 chisel kit is provided along with the tool.



SN-1032

AIR FLUX CHIPPER

Air inlet : 1/4"



include the chisel

## SC-05C[SET] / 06C[SET]

- 1pc- Air Hammer (Various Selections)
- 5pcs-Chisel Kits
- 1pc- Spring Retainer

Item No.	Shank	Contents
SC-0517C	Round Shank	SC-211C
SC-0527C	Round Shank	SC-212C
Item No.	Shank	Contents
SC-0617C	Hex Shank	SC-221C
SC-0627C	Hex Shank	SC-222C



## SC-33C/34C

NEEDLE SCALER ADAPTOR  
FOR AIR HAMMER TOOLS USE ROUND / HEX  
19pcs  $\varnothing$  3mmx180mm

Item No.	Shank	Contents
SC-33C	Round Shank	SC-211
SC-34C	Hex Shank	SC-221



- SC-33C - / Round
- SC-34C - / Hex

## SN-9101/9103 SN-9201/9203

Chisel For SN-31/SN-32 SERIES

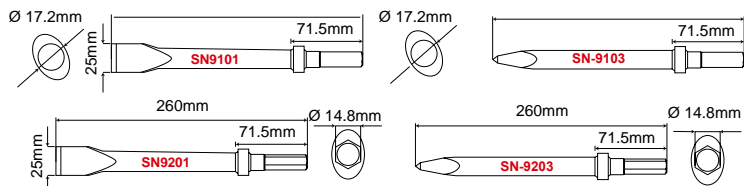



	Shank	Chuck Size	Stroke Length	Blow Minute	Avg. Air Consumption	Air Pressure	Overall Length	Net Weight		Air Hose	Sound Pressure	Vibration Level
		inch(mm)	mm	bpm	CFM (L/min)	PSI (bar)	Inch (mm)	LBS	kg	Inch	dBA	m/s <sup>2</sup>
				bpm								
SC-211C	●	0.401(10.2)	67	3200	4.0(113)	90(6.3)	6-7/8"(175)	3.7	1.7	3/8"	98.0	12.3
SC-221C	⬡	0.393(10)	67	3200	4.0(113)	90(6.3)	6-7/8"(175)	3.7	1.7	3/8"	98.0	12.3
SC-212C	●	0.401(10.2)	89	2200	4.0(113)	90(6.3)	8-7/8"(225)	4.4	2.0	3/8"	94.7	13.2
SC-222C	⬡	0.393(10)	89	2200	4.0(113)	90(6.3)	8-7/8"(225)	4.4	2.0	3/8"	94.7	13.2
SC-331C	●	0.401(10.2)	71	3000	7.8(220)	90(6.3)	7-31/64"(190)	3.7	1.7	3/8"	92.0	9.5
SC-332C	●	0.401(10.2)	92	2200	8.2(232)	90(6.3)	8-63/64"(228)	4.4	2.0	3/8"	94.0	10.6
SC-341C	⬡	0.393(10)	71	3000	7.8(220)	90(6.3)	7-31/64"(190)	3.7	1.7	3/8"	92	9.5
SC-342C	⬡	0.393(10)	92	2200	8.2(232)	90(6.3)	8-63/64"(228)	4.4	2.0	3/8"	94	10.6
SN-1032	■	0.51(13)	33	4000	4.23(120)	90(6.3)	11-1/2"(290)	2.9	1.33	3/8"	91.0	14.5

**NEW PRODUCT**



**SC-371**

**AIR HAMMER**  
Do not include the chisel



**SC-371C**

**AIR HAMMER**  
include the chisel

**HAMMER CHISEL**

- SC-9406R  
3/16"
- SC-9405R  
5/32"
- SC-9404R  
1/8"
- SC-9403R  
3/32"
- SC-9432R  
1"



	Shank Size	Stroke Length	Blow Minute	Avg. Air Consumption	Air Pressure	Overall Length	Net Weight		Air Hose	Sound Pressure	Vibration Level
	inch(mm)	mm	bpm	CFM (L/min)	PSI (bar)	Inch (mm)	LBS	kg	Inch	dBA	m/s <sup>2</sup>
			bpm								
SC-371	3/8"(10.2)	62.5	3000	7.8(180)	90(6.3)	7-1/8"(180)	3.7	1.7	3/8"	95.0	8.8

# AIR HAMMER



## SN-3111C/3112C SN-3113C/3114C

Round Shank

## SN-3121C/3122C SN-3123C/3124C

Hex Shank



## SN-3212C/3213C SN-3214C

Round Shank

## SN-3222C/3223C SN-3224C

Hex Shank



AIR HAMMER

	Shank	Chuck Size	Stroke Length	Blow Minute	Avg. Air Consumption	Air Pressure	Overall Length	Net Weight		Air Hose	Sound Pressure	Vibration Level
		inch(mm)	mm	bpm	CFM (L/min)	PSI (bar)	Inch (mm)	LBS	kg	Inch	dBA	m/s <sup>2</sup>
	● ● ●											
SN-3111C	●	0.68(17.2)	75	2500	10.0(283)	90(6.3)	15-1/2"(395)	15.4	7.0	1/2"	115.3	8.0
SN-3121C	●	0.58(14.8)	75	2500	10.0(283)	90(6.3)	15-1/2"(395)	15.4	7.0	1/2"	115.3	8.0
SN-3112C	●	0.68(17.2)	90	2300	20.0(566)	90(6.3)	16"(405)	16.1	7.3	1/2"	114.3	9.4
SN-3122C	●	0.58(14.8)	90	2300	20.0(566)	90(6.3)	16"(405)	16.1	7.3	1/2"	114.3	9.4
SN-3113C	●	0.68(17.2)	127	2000	22.0(622.6)	90(6.3)	17-3/4"(450)	17.6	8.0	1/2"	113.3	4.8
SN-3123C	●	0.58(14.8)	127	2000	22.0(622.6)	90(6.3)	17-3/4"(450)	17.6	8.0	1/2"	113.3	4.8
SN-3114C	●	0.68(17.2)	154	1600	24.0(679.2)	90(6.3)	18-1/2"(470)	18.3	8.3	1/2"	114.1	6.2
SN-3124C	●	0.58(14.8)	154	1600	24.0(679.2)	90(6.3)	18-1/2"(470)	18.3	8.3	1/2"	114.1	6.2
SN-3212C	●	0.68(17.2)	78	2300	20.0(566)	90(6.3)	14-5/8"(373)	17.2	7.8	1/2"	114.3	9.4
SN-3222C	●	0.58(14.8)	78	2300	20.0(566)	90(6.3)	14-5/8"(373)	17.2	7.8	1/2"	114.3	9.4
SN-3213C	●	0.68(17.2)	119	1900	22.0(622.6)	90(6.3)	16-1/2"(419)	18.7	8.5	1/2"	113.3	4.8
SN-3223C	●	0.58(14.8)	119	1900	22.0(622.6)	90(6.3)	16-1/2"(419)	18.7	8.5	1/2"	113.3	4.8
SN-3214C	●	0.68(17.2)	142	1700	24.0(679.2)	90(6.3)	17-1/2"(445)	19.4	8.8	1/2"	114.1	6.2
SN-3224C	●	0.58(14.8)	142	1700	24.0(679.2)	90(6.3)	17-1/2"(445)	19.4	8.8	1/2"	114.1	6.2

★★★   
**SN-1268**  
 AIR NEEDLE SCALER  
 Air inlet : 1/4"



★★★   
**SN-1288**  
 AIR NEEDLE SCALER  
 Air inlet : 1/4"



★★★   
**SN-1368**  
 AIR NEEDLE SCALER  
 Air inlet : 1/4"



★★★★   
**SN-2124**  
 AIR PISTOL GRIP NEEDLE SCALER  
 Air inlet : 1/4"



★★★★   
**SN-2128**  
 AIR PISTOL GRIP NEEDLE SCALER  
 Air inlet : 1/4"



★★★★   
**SN-2110**  
 AIR PISTOL GRIP NEEDLE SCALER  
 Air inlet : 1/4"



**SN-1268K001**  
 DUST SHROUD ATTACHMENT  
 Available with SN-1268













**SN-2128K001**  
 DUST SHROUD ATTACHMENT  
 Available with SN-2128



**SN-2110K001**  
 DUST SHROUD ATTACHMENT  
 Available with SN-2110



	Needle Diameter	Numbers of Needle	Stroke Length	Blow Per Minute	Avg. Air Consumption	Air Pressure	Overall Length	Net Weight	Air Hose	Sound Pressure	Vibration Level
	mm	inch(mm)	mm	bpm	CFM (L/min)	PSI (bar)	Inch (mm)	LBS kg	Inch	dBA	m/s <sup>2</sup>
											
SN-1268	3x180	19	28	4600	15(424)	90(6.3)	18-1/8"(460)	6.2 2.80	3/8"	91.0	13.7
SN-1288	3x125	12	32	5500	3(85)	90(6.3)	11-3/8"(290)	2.9 1.30	3/8"	86.0	7.7
SN-1368	3x180	19	27	3400	16(453)	90(6.3)	17"(430)	5.9 2.70	3/8"	91.0	13.7
SN-2110	3x180	19	33	3700	15(424)	90(6.3)	13"(330)	6.1 2.80	3/8"	97.0	9.7
SN-2128	3x180	28	28	3500	7.4(198)	90(6.3)	13-9/16"(335)	6.2 2.80	3/8"	100.0	8.1
SN-2124	3x180	23	27	4000	7.4(209)	90(6.3)	13-9/16"(350)	7.9 3.60	3/8"	99.0	14.8

# AIR HYDRAULIC RIVETER

AIR HYDRAULIC RIVETER

## PA-MC AUTOMATIC MANDREL COLLECTION

### CONTENTS

3/32" (2.4mm) 220pcs  
1/8" (3.2mm) 160pcs  
5/32" (4.0mm) 110pcs  
3/16" (4.8mm) 80pcs



## PE-MC AUTOMATIC MANDREL COLLECTION



### PA-111

Air inlet : 1/4"



### PA-201

Air inlet : 1/4"



### PA-201V

Air inlet : 1/4"  
Vacuum Type



### PA-211

Air inlet : 1/4"



### PA-321

Air inlet : 1/4"



### PA-312V

Vacuum Type Air inlet : 1/4"



### PA-301V

Vacuum Type Air inlet : 1/4"



### PA-301

Air inlet : 1/4"



### PA-301D

Air inlet : 1/4"



### PA-301L

Air inlet : 1/4"



### PA-203N

Air inlet : 1/4"





	Traction Power lb.-f/(kg.-f)	Stroke Length mm	Capacity mm	Air Pressure PSI (bar)	Avg. Air Consumption L/cycle	Net Weight LBS kg		Air Hose Inch	Sound Pressure dBA	Vibration Level m/s <sup>2</sup>
PA-111	4100(1860)	26	4.8-6.4	90(6.3)	2.88	6.6	3.00	3/8"	82.0	0.8
PA-201 PA-201V	3534(1603)	14	2.4-6.4	90(6.3)	2.32	3.9	1.80	3/8"	79.7	0.5
PA-211	3748(1700)	18	2.4-6.4	90(6.3)	2.9	3.8	1.75	3/8"	79.7	0.8
PA-321	2612(1185)	22	2.4-4.8	90(6.3)	1.48	3.3	1.50	3/8"	79.7	0.4
PA-312V	1983(900)	18	2.4-4.8	90(6.3)	1.8	3.8	1.74	3/8"	75.3	0.4
PA-301V	2303(1045)	16	2.4-4.8	90(6.3)	1.48	3.3	1.50	3/8"	79.7	0.3
PA-301	2303(1045)	16	2.4-4.8	90(6.3)	1.48	3.3	1.50	3/8"	79.7	0.3
PA-301D	2303(1045)	16	2.4-4.8	90(6.3)	1.48	3.3	1.50	3/8"	79.7	0.3
PA-301L	2303(1045)	16	2.4-4.8	90(6.3)	1.48	3.3	1.50	3/8"	79.7	0.3
PA-203	2640(1200)	16	3.2-6.4	90(6.3)	1.48	3.3	1.50	3/8"	79.7	0.5

**PB-2601**

**AIR HYDRAULIC NUT SETTER**  
Air inlet : 1/4"



**PA-211TS**

**AIR HYDRAULIC RIVETER**  
Air inlet : 1/4"



**PB-2402**

**AIR HYDRAULIC RIVET NUT TOOL**  
Air inlet : 1/4"



**PB-1305  
PB-1308  
PB-1310**

**AIR RIVET NUT TOOL**  
Air inlet : 1/4"



**PB-1312**

**AIR RIVET NUT TOOL**  
Air inlet : 1/4"



	Traction Power lb.-f/(kg.-f)	Free Speed R.P.M	Stroke Length mm	Capacity mm	Air Pressure PSI (bar)	Avg. Air Consumption L/cycle	Net Weight LBS kg		Air Hose Inch	Sound Pressure dBA	Vibration Level m/s <sup>2</sup>
PB-2601	4300(594.5)	3500	0-7.0	M3 - M12	90 (6.3)	7.5	5.4	2.46	3/8"	80	1.2
PA-211TS	3748(1700)	----	18	6.4 & 8.0	90(6.3)	2.90	3.80	1.75	3/8"	79.7	0.8
PB-2402	3638(1650)	----	9	Steel M4.M10 Stainless M4.M8	90(6.3)	1.50	3.40	1.55	3/8"	82.0	0.8
PB-1305	----	1200	----	M3.M4.M5	90(6.3)	7.8	2.42	1.10	3/8"	86.0	1.6
PB-1308	----	600	----	M6.M8	90(6.3)	7.8	2.86	1.30	3/8"	86.0	1.6
PB-1310	----	400	----	M8.M10	90(6.3)	7.8	2.80	1.30	3/8"	86.0	1.6
PB-1312	----	400	----	M10.M12	90(6.3)	7.8	2.80	1.27	3/8"	86.0	1.6

ITEM	MATERIAL		RIVET DIAMETER( ØMM)						
	RIVET	RIVET MANDREL	(2.5) 2.4	(3.0) 3.2	4.0	(5.0) 4.8	6.4	7.2	8.0
<b>PA-111</b>	aluminum	aluminum					■		
	aluminum	steel					■		
	steel	steel					■		
	stainless	steel					■		
	stainless	stainless					■		
<b>PA-201</b>	aluminum	aluminum	■	■	■	■	■		
	aluminum	steel	■	■	■	■	■		
	steel	steel	■	■	■	■	■		
	stainless	steel	■	■	■	■	■		
	stainless	stainless	■	■	■	■	■		
<b>PA-201V</b>	aluminum	aluminum	■	■	■	■	■		
	aluminum	steel	■	■	■	■	■		
	steel	steel	■	■	■	■	■		
	stainless	steel	■	■	■	■	■		
	stainless	stainless	■	■	■	■	■		
<b>PA-211</b>	aluminum	aluminum	■	■	■	■	■		
	aluminum	steel	■	■	■	■	■		
	steel	steel	■	■	■	■	■		
	stainless	steel	■	■	■	■	■		
	stainless	stainless	■	■	■	■	■		
<b>PA-211VMC</b>	aluminum	aluminum	■	■	■	■	■		
	aluminum	steel	■	■	■	■	■		
	steel	steel	■	■	■	■	■		
	stainless	steel	■	■	■	■	■		
	stainless	stainless	■	■	■	■	■		
<b>PA-301</b>	aluminum	aluminum	■	■	■	■	■		
	aluminum	steel	■	■	■	■	■		
	steel	steel	■	■	■	■	■		
	stainless	steel	■	■	■	■	■		
	stainless	stainless	■	■	■	■	■		
<b>PA-301V</b>	aluminum	aluminum	■	■	■	■	■		
	aluminum	steel	■	■	■	■	■		
	steel	steel	■	■	■	■	■		
	stainless	steel	■	■	■	■	■		
	stainless	stainless	■	■	■	■	■		
<b>PA-301D</b>	aluminum	aluminum	■	■	■	■	■		
	aluminum	steel	■	■	■	■	■		
<b>PA-301L</b>	steel	steel	■	■	■	■	■		
	stainless	stainless	■	■	■	■	■		
<b>PA-321</b>	aluminum	aluminum	■	■	■	■	■		
	aluminum	steel	■	■	■	■	■		
	steel	steel	■	■	■	■	■		
	stainless	steel	■	■	■	■	■		
	stainless	stainless	■	■	■	■	■		
<b>PA-312V</b>	aluminum	aluminum	■	■	■	■	■		
	aluminum	steel	■	■	■	■	■		
	steel	steel	■	■	■	■	■		
	stainless	steel	■	■	■	■	■		
	stainless	stainless	■	■	■	■	■		
<b>PA-301VMC</b>	aluminum	aluminum	■	■	■	■	■		
	aluminum	steel	■	■	■	■	■		
	steel	steel	■	■	■	■	■		
	stainless	steel	■	■	■	■	■		
	stainless	stainless	■	■	■	■	■		
<b>PA-211TS</b>	aluminum	aluminum						■	
	aluminum	steel						■	
	steel	steel						■	
	stainless	steel						■	
	stainless	stainless						■	

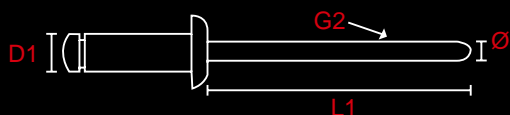

**Hydraulic cylinder  
Recommended Oil**

- SHELL Tellus NO.46
- ESSO Teresso NO.46
- MOBIL D.T.E 25 oil
- USM Spec NO.300B Oil
- CPC Circulation Oil R68

	Rivet (D1)	Mandrel (L1)	Rivet Dia. (Ø)
<b>Blind Rivet</b>	2.4mm	above27mm	1.42~1.51(G2)
	3.2mm	above28mm	1.83~1.92(G2)
	4.0mm	above29mm	2.28~2.42(G2)
	4.8mm	above30mm	2.64~2.91(G2)
	6.4mm	above30mm	3.84~4.15(G2)
<b>PA-211TS</b>	6.4mm	above40mm	3.84~4.15(G2)
	8.0mm	above40mm	4.35~4.65(G2)

# RIVETER ADAPTOR RIVET NUT ADAPTOR

**PB-9006**  
M6 RIVET NUT ADAPTOR

**PA-9048**  
4.8mm (3/16") RIVETER ADAPTOR

**PB-9010**  
M10 RIVET NUT ADAPTOR

**PA-9064**  
6.35mm (1/4") RIVETER ADAPTOR



**PB-9006P**  
M6 RIVET NUT ADAPTOR

**PB-9010P**  
M10 RIVET NUT ADAPTOR

**PA-9048P**  
4.8mm (3/16") RIVETER ADAPTOR

**PA-9064P**  
6.35mm (1/4") RIVETER ADAPTOR



**PA-9048PT**

Riveter Adaptor

**PA48PB06T**

Riveter Adaptor + Rivet Nut Adaptor

**PB-9006PT**

Rivet Nut Adaptor



## Assembling And Using Before First Use

Remove the unit and the accessory out of the packaging.  
Keep packaging materials out of reach of children.

There is risk of suffocation.



## TECHNICAL DATA

### PA-9064

Dimensions	59mm x173mm(2-11/32 x 6-3/4 inch)
Net Weight	330g=0.73 lbs
Gross Weight	500g=1.10 lbs
Nosepiece	3.2mm(1/8), 4.0mm(5/32)
Nosepiece	4.8mm(3/16),6.4mm(1/4)
Hex Shank	1/4" (6.35 mm)
Cordless Drill	14.4V ,18V
Cordless Drive	14.4V ,18V
Reversible electric	1/2"Drill
Reversible pneumatic	1/2"Drill
Min. Torque Strength	50 Nm = 37 ft/lbs
Max. rpm	1,000 rpm

1. Hex Shank	1/4 (6.35 mm)
2. Housing	PA+GF
3. Nosepiece	3.2mm, 4.0mm, 4.8mm, 6.4mm
4. Sight Window	Blind Rivet Loading
5. Wrench	1PC
6. Handle	1PC

### PB-9006

Dimensions	59mm x172mm(2-11/32" x 6-25/32")
Weight	280g=0.62 lbs
Nosepiece	M3 M4 M5 M6
Hex Shank	1/4" (6.35 mm)
Cordless Drill	12V 14.4V
Cordless Drive	12V 14.4V
Reversible electric	Drill (Advice 500W)
Reversible pneumatic	Drill (Advice 3/8")
Min. Torque Strength	15 Nm = 11 ft/lbs
Max. rpm	1000 rpm

### PA-9048

Dimensions	59mm x158mm(2-11/32" x 6-1/4")
Net Weight	318g=0.70 lbs
Gross Weight	368g=0.81 lbs
Nosepiece	2.4mm(3/32),3.2mm(1/8)
Nosepiece	4.0mm(5/32),4.8mm(3/16)
Hex Shank	1/4" (6.35 mm)
Cordless Drill	12V 14.4V 18V
Cordless Drive	12V 14.4V 18V
Reversible electric	3/8"Drill
Reversible pneumatic	3/8"Drill
Min. Torque Strength	11 Nm = 8 ft/lbs
Max. rpm	1,000 rpm

1 Hex Shank	1/4 (6.35 mm)
2 Housing	PA+GF
3 Nosepiece	2.4mm , 3.2mm, 4.0mm, 4.8mm
4 Sight Window	Blind Rivet Loading
5 Wrench	1PC

### PB-9010

Dimensions	59mm x180mm(2-11/32" x 7-3/32")
Weight	350g=0.77 lbs
Nosepiece	M6 M8 M10
Hex Shank	1/4" (6.35 mm)
Cordless Drill	14.4V
Cordless Drive	18V
Reversible electric	Drill (Advice 500W)
Reversible pneumatic	Drill (Advice 1/2")
Min. Torque Strength	100 Nm = 73.7 ft/lbs
Max. rpm	800 rpm

# AIR NAILER & AIR STAPLER

## ★★ SJ-FN90E

**Air Framing Nailer 34°**  
Air inlet : 1/4"

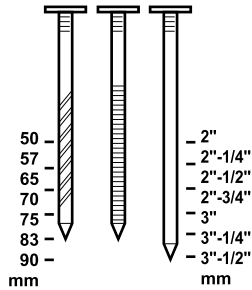

## ★★ SJ-1650T

**AIR NAILER**  
**Safety trigger**  
Air inlet : 1/4"

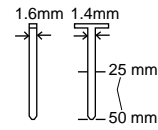

	Collated mm	Nail Head	Nail Length mm(inch)	Shank Dia. mm	Load Capacity Nails	Weight kgs	Working Pressure P	
SJ-FN90E	Paper / Wire	Clipped Head	50-90(2"-3-1/2")	2.9	3.3	75-105	3.9	90

## ★★ SJ-1830F

**SJ-C1830F**  
**AIR NAILER**  
**Safety trigger**  
Air inlet : 1/4"

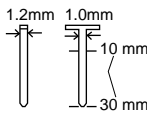

## ★★ SU-C422J

**SU-C1022J**  
**AIR NAILER**  
Air inlet : 1/4"

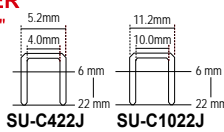

## ★★ SJ-TN64

**AIR CONCRETE NAILER**  
Air inlet : 1/4"

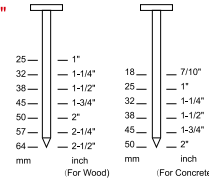

## ★★ SJ-BNF1664

**AIR BRAD NAILER**  
Air inlet : 1/4"

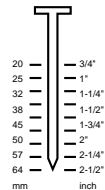

## ★★ SU-9025

**AIR STAPLER**  
**Safety trigger**  
Air inlet : 1/4"

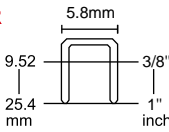

## ★★ SJ-1850F

**AIR NAILER**  
**Safety trigger**  
Air inlet : 1/4"

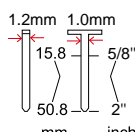

## ★★ SU-8016

**AIR STAPLER**  
**Safety trigger**  
Air inlet : 1/4"

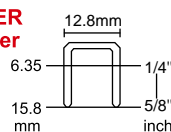

## ★★ SU-9040

**AIR STAPLER**  
**Safety trigger**  
Air inlet : 1/4"

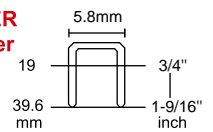

## ★★ SU-H3518S

**SU-H3522S**  
**SU-H3218S**  
**SU-H3222S**  
**HAND CARTON STAPLER**

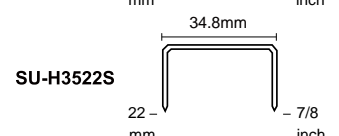
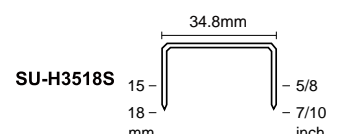
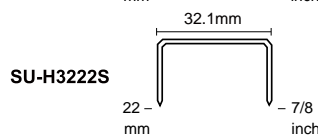
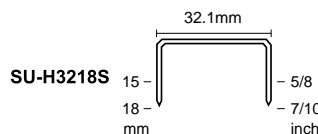





**SU-A3518S**  
**SU-A3522S**  
**SU-A3218S**  
**SU-A3222S**  
**AIR CARTON STAPLER**

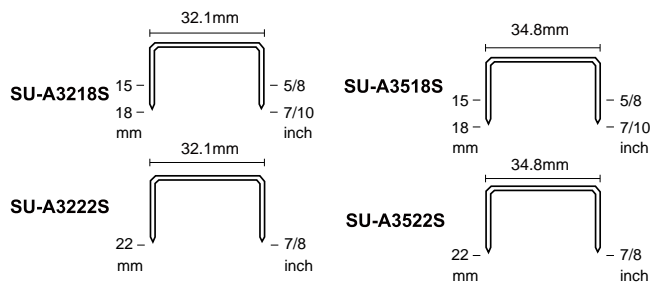

	Dimensions		Nail Length	Crown	Shank (Thickness/Width)		Load Capacity	Weight	Working Pressure
	mm	mm			mm	mm			
SU-A3518S	200	102	15 & 18	34.8	0.9	2.2	100	2.53	90
SU-A3522S	200	102	22	34.8	0.9	2.2	100	2.53	90
SU-A3218S	200	102	15 & 18	32.1	0.9	1.9	100	2.53	90
SU-A3222S	200	102	22	32.1	0.9	1.9	100	2.53	90
SU-H3518S	310	102	15 & 18	34.8	0.9	2.2	100	2.18	----
SU-H3522S	310	102	22	34.8	0.9	2.2	100	2.18	----
SU-H3218S	310	102	15 & 18	32.1	0.9	1.9	100	2.18	----
SU-H3222S	310	102	22	32.1	0.9	1.9	100	2.18	----

	Head Dia.	Gauge	Nail Length	Crown		Shank (Thickness/Width)		Load Capacity	Weight	Working Pressure
				mm	mm	mm	mm			
SJ-1650T	2.8	16	20-50 (3/4"-2")	----	----	1.4	1.60	100	2.35	90
SJ-1830F	1.9	18	10-30 (3/8"-1-2/11")	----	----	1.0	1.2	100	1.2	90
SU-C422J	----	20	6-22 (1/4"-7/8")	4	0.6x1.2	----	----	100	1.15	90
SU-C1022J	1.9	20	6-22 (1/4"-7/8")	10	0.6x1.2	----	----	100	1.20	90
SJ-1850F	----	18	20-50 (3/4"-2")	----	----	1.0	1.2	100	1.4	90
SU-8016	----	21	6-16 (1/4"-5/8")	12.8	0.65x0.95	----	----	100	0.90	90
SU-9025	----	18	10-25 (3/8"-1")	5.8	1.0x1.25	----	----	100	1.1	90
SU-9040	----	18	10-40 (3/4"-1-9/16")	5.8	1.0x1.25	----	----	100	2.20	90
SJ-TN64	7.5	13	(18-64)	----	----	2.5	2.50	80	2.35	90
SJ-BNF-1664	2.8	16	(20-64)	----	----	1.4	1.60	100	2.35	90



**SJ-CN55**

**COIL NAILER**  
**Safty Trigger**  
 Air inlet : 1/4"

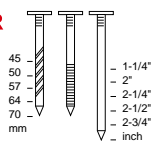

**SJ-CN70**

**COIL NAILER**  
**Safty Trigger**  
 Air inlet : 1/4"

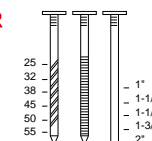

**SJ-CN57**

**57mm AIR COIL NAILER**  
**Safty Trigger**  
 Air inlet : 1/4"



**SJ-CN65**

**65mm AIR COIL NAILER**  
**Safty Trigger**  
 Air inlet : 1/4"

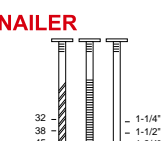

	Shank Dia.	Head Dia.	Nail Length	Collated	Driving Power	Load Capacity	Dimensions	Weight	Working Pressure
	mm	mm	mm		(ft-lb)		(H*W*L)mm	kg	PSI
SJ-CN55	2.1-2.3	5.0-5.7	25-57	Wire	36.54	300-350	283*131*270	2.8	90
SJ-CN70	2.3-2.9	5.7-7.0	45-70	Wire	61.07	150-300	303*129*307	3.7	90
SJ-CN57	2.1-2.3	5.0-6.0	25-57	Wire / Plastic Sheet	36.40	200-300	310*130*300	2.2	90
SJ-CN65	2.3-2.5	5.0-6.0	32-65	Wire / Plastic Sheet	39.70	200-300	330*130*300	2.3	90

# AIR GREASE GUN & BLOW GUN

LUBRICATION P.215  
SG-101 KIT / SO-10 / SO-10T KIT



**SG-400C**  
COMPOSITE AIR GREASE GUN  
Air inlet : 1/4"



**SG-400/500**  
AIR GREASE GUN  
Air inlet : 1/4"  
Note: SG-500 for Australia



**SG-401/501**  
AIR GREASE GUN / CONTINUOUS TYPE  
Air inlet : 1/4" Note: SG-501 for Australia



**SG-902**  
Grease Tube Adapter



**SG-405**  
SG-400 + SG-902 400 ml



**SG-407**  
SG-401 + SG-902 400 ml  
Continuous Type  
Air Grease Gun

Key Spec:  
Single shot type  
Air inlet : 1/4"  
19.6mm & 33.6mm  
Thread Adapter Included

	Air Inlet inch	Working Pressure kgf/cm <sup>2</sup>	Proof Pressure kgf/cm <sup>2</sup>	Capacity C.C	Air Hose Inch	Net Weight LBS kg	Sound Pressure dBA	Vibration Level m/s <sup>2</sup>
	—			—		 		
SG-400	1/4"	2.8-8.4	10.5	400	3/8"	3.2 1.46	80.2	0.7
SG-500	1/4"	2.8-8.4	10.5	500	3/8"	3.52 1.6	80.2	0.7
SG-400C	1/4"	2.8-8.4	10.5	400	3/8"	2.2 1.0	81.4	0.6
SG-401	1/4"	2.8-8.4	10.5	400	3/8"	3.52 1.6	74.0	2.0
SG-501	1/4"	2.8-8.4	10.5	500	3/8"	3.74 1.7	74.0	2.0



**JC-491**  
STANDARD SAFETY TIP  
Available with  
JC-491 for JC-405 JC-410 JC-412  
JC-424 JC-435



**JC-405/410/412**  
**JC-424/435**  
AIR BLOW GUN  
Air inlet : 1/4"



# ★★ JC-640/641/680

**SUPER AIR BLOW GUN**

JC-640/JC-641 40"  
JC-680 80"

Air inlet : 1/4"



# ★★ JC-0424[SET]

**AIR BLOW GUN**

Contents  
JC-405 8PCS  
JC-410 8PCS  
JC-412 8PCS  
Air inlet : 1/4"



# JC-0415[SET]

**AIR BLOW GUN**

Contents  
JC-405 15PCS  
Air inlet : 1/4"



	Nozzle Length inch	Working Pressure PSI (bar)	Max Pressure PSI (bar)	Avg. Air Consumption CFM(L/min)	Avg. Air Consumption CFM(L/min)	Net Weight		Air Hose Inch	Sound Pressure dBA
	L	Working	MAX	1/4" Hous	3/8" Hous	lb	kg		???)
JC-202	7"-12"	90-120(6.2-8.5)	220(15.1)	-----	5.10(144)	0.38	0.17	3/8"	90.0
JC-304	4"	75-120(5.3-8.5)	150(10.6)	13.0(368)	15.0(425)	0.15	0.07	3/8"	90.0
JC-310	10"	75-120(5.3-8.5)	150(10.6)	13.0(368)	15.0(425)	0.22	0.10	3/8"	90.0
JC-313	13"	75-120(5.3-8.5)	150(10.6)	13.0(368)	15.0(425)	0.24	0.11	3/8"	90.0
JC-320	20"	75-120(5.3-8.5)	150(10.6)	13.0(368)	15.0(425)	0.31	0.14	3/8"	90.0
JC-340	40"	75-120(5.3-8.5)	150(10.6)	13.0(368)	15.0(425)	0.50	0.23	3/8"	90.0
JC-405	5"	75-120(5.3-8.5)	150(10.6)	13.0(368)	15.0(425)	0.24	0.11	3/8"	90.0
JC-410	10"	75-120(5.3-8.5)	150(10.6)	13.0(368)	15.0(425)	0.26	0.12	3/8"	90.0
JC-412	12"	75-120(5.3-8.5)	150(10.6)	13.0(368)	15.0(425)	0.28	0.13	3/8"	90.0
JC-424	24"	75-120(5.3-8.5)	150(10.6)	13.0(368)	15.0(425)	0.31	0.14	3/8"	90.0
JC-435	35"	75-120(5.3-8.5)	150(10.6)	13.0(368)	15.0(425)	0.55	0.25	3/8"	90.0
JC-640	40"	75-120(5.3-8.5)	150(10.6)	13.0(368)	15.0(425)	0.75	0.34	3/8"	90.0
JC-641	40"	75-120(5.3-8.5)	150(10.6)	13.0(368)	15.0(425)	0.75	0.34	3/8"	90.0
JC-680	80"	75-120(5.3-8.5)	150(10.6)	13.0(368)	15.0(425)	1.41	0.64	3/8"	90.0

## AUTO REPAIR TOOL

# NC-0208[SET]

**1/4" DRIVE AIR IMPACT WRENCH 8 PCS**

**Twin Dog Type**

Air inlet : 1/4"

- 1pc 1/4" Air Impact Wrench (NC-2710)
- 5pcs Socket:8.9.10.11.12mm
- 1pc 1/4" Drive Universal Joint
- 1pc 1/4" Extension Bar
- 1pc Plug



	Square Drive Inch	Bolt Capacity Inch (mm)	Torque Range FT-LB (Nm)	Max Torque FT-LB Nm		Free Speed R.P.M	Avg. Air Consumption CFM (L/min)	Air Pressure PSI (bar)	Overall Length Inch (mm)	Net Weight		Air Hose Inch	Sound Pressure dBA	Vibration Level m/s <sup>2</sup>
						No			L	lb	kg		???)	((OO))
NC-2710	1/4"	M8	7.4-29.5 (10-40)	29	40	11000	5.3(150)	90 (6.3)	5-3/8" (136)	1.76	0.8	3/8"	91.0	3.4

# AUTO REPAIR TOOL



## QB-0618[SET]

**90° MINI SANDER 18 PCS SET**  
Air inlet : 1/4"

Contents:

- QB-625 (1pcs)
- Disc 2" PAD (1pcs)
- Disc 3" PAD (1pcs)
- Removal Sandering 2" #80-YL (1pcs)
- 2" #150-RD (2pcs)
- 2" #300-BL (2pcs)
- 2" Stripping Disc
- 3" #80-YL (1pcs)
- 3" #150-RD (2pcs)
- 3" #300-BL (2pcs)
- 3" Stripping Disc
- Adaptor
- Spanner
- Oil



QB-625



	Pad Dia / Arbor Size	Free Speed	Avg. Air Consumption	Air Pressure	Overall Length	Motor	Net Weight	Air Hose	Sound Pressure	Vibration Level
	inch	R.P.M	CFM	PSI (bar)	Inch (mm)	HP	LBS(kg)	Inch	dBA	m/s <sup>2</sup>
QB-625	2" / 3"	15000	17.2	90(6.3)	7-1/8"(180)	0.6	1.3 / 0.61	3/8"	75	2.5



## NC-2210N[SET]

**1/4" DRIVE AIR IMPACT WRENCH**  
Twin Dog Type Air inlet : 1/4"

Contents:

- + 1 pc 1/4" Impact Socket 8 mm
- + 1 pc 1/4" Impact Socket 9 mm
- + 1 pc 1/4" Impact Socket 10 mm
- + 1 pc 1/4" Impact Socket 11 mm
- + 1 pc 1/4" Impact Socket 12 mm
- + 1 pc 1/4" Extension Bar (L:50mm)
- + 1 pc 1/4" Extension Bar (L:125mm)
- + 1 pc 1/4" Universal Joint
- + 1 pc 1/4" Plug
- + 1 pc Air Impact Wrench



NC-2210



	Square Drive	Bolt Capacity	Torque Range	Max Torque	Free Speed	Avg. Air Consumption	Air Pressure	Overall Length	Net Weight	Air Hose	Sound Pressure	Vibration Level
	Inch	Inch (mm)	FT-LB (Nm)	FT-LB Nm	R.P.M	CFM (L/min)	PSI (bar)	Inch (mm)	LBS kg	Inch	dBA	m/s <sup>2</sup>
NC-2210	1/4"	M5	4-45( 6-61)	50 / 67.8	11000	1.8(51)	90(6.3)	6-17/32"(166)	1.4 / 0.65	3/8"	77.0	1.8



## QA-651N [SET]

**AIR DIE GRINDER**  
Air inlet : 1/4"

Contents:

- + 1 pc Air Die Grinder
- + 1 pc Collet : 3mm (or1/8")
- + 5 pcs Grinder Stones 3mm
- + 5 pcs Grinder Stones 6mm
- + 1 pc 1/4" Plug
- + 1 pc Oil Box
- + 2 pcs Spanner Wrench



QA-651



	Collet Size	Free Speed	Avg. Air Consumption	Air Pressure	Overall Length	Hose Length	Net Weight	Air Hose	Sound Pressure	Vibration Level	Motor
	inch(mm)	R.P.M	CFM (L/min)	PSI (bar)	Inch (mm)	mm	LBS(kg)	Inch	dBA	m/s <sup>2</sup>	HP
QA-651	1/4" (6)	18000	2.7(76)	90(6.3)	5" (127)	----	1.10 / 0.5	3/8"	74.0	0.3	0.3





## QP-212N[SET]

### AIR HIGH SPEED SANDER

Air inlet : 1/4"

#### Contents:

- + 1 pc Air High Speed Sander
- + 1 pc 2" Rubber PAD(1/4"-20)
- + 1 pc 2" Pad Die#80
- + 1 pc 2" Stripping Disc #80-YL(Coarse)
- + 1 pc 2" Stripping Disc #150-RD(Med)
- + 1 pc 3" Rubber PAD(1/4"-20)
- + 1 pc 3" Pad Die#80
- + 1 pc 3" Stripping Disc #80-YL(Coarse)
- + 1 pc 3" Stripping Disc #150-RD(Med)
- + 1 pc 1/4" Plug
- + 1 pc Oil Box
- + 1 pc Spanner Wrench



QP-212

	Pad Dia	Free Speed	Avg. Air Consumption	Air Pressure	Overall Length	Motor	Net Weight	Air Hose	Sound Pressure	Vibration Level	Spindle Size
	inch(mm)	R.P.M	CFM (L/min)	PSI (bar)	Inch (mm)	HP	LBS(kg)	Inch	dBA	m/s <sup>2</sup>	
QP-212	2" or 3"	18000	2.1(59)	90(6.3)	4-1/4"(107)	0.3	1.1 0.50	3/8"	73.0	0.9	1/4"-20



## QP-213N[SET]

### Air Orbit Sander

Air inlet : 1/4"

#### Contents:

- + 1 pc Air Sander
- + 1 pc 2" PAD(5/16"-24)
- + 1 pc 3" PAD (5/16"-24)
- + 10 pcs 2" Sandpaper#180
- + 10 pcs 2" Sandpaper#220
- + 10 pcs 2" Sandpaper#320
- + 1 pc 1/4" Plug
- + 1 pc Oil Box
- + 2 pcs Spanner Wrench
- + 10 pcs 3" Sandpaper#180
- + 10 pcs 3" Sandpaper#220
- + 10 pcs 3" Sandpaper#320



QP-213

	Pad Dia	Free Speed	Avg. Air Consumption	Air Pressure	Overall Length	Motor	Net Weight	Air Hose	Sound Pressure	Vibration Level	Spindle Size
	inch(mm)	R.P.M	CFM (L/min)	PSI (bar)	Inch (mm)	HP	LBS(kg)	Inch	dBA	m/s <sup>2</sup>	
QP-213	3"(76)	18000	2.1(59)	90(6.3)	4-5/8"(117)	0.3	1.1 0.50	3/8"	76.0	1.2	5/16"-24



## QP-223N[SET]

### AIR MINI POLISHER

Air inlet : 1/4"

#### Contents:

- + 1 pc Air Mini Polisher(QP-223)
- + 1 pc 3"PAD(5/16"-24)
- + 1 pc 3"Sponge (Medlum)
- + 1 pc 3"Sponge (Rough)
- + 1 pc 3"Wool Bonnet
- + 1 pc 1/4"Plug
- + 1 pc Spanner Wrench



QP-223

	Pad Dia	Free Speed	Avg. Air Consumption	Air Pressure	Overall Length	Motor	Net Weight	Air Hose	Sound Pressure	Vibration Level	Spindle Size
	inch(mm)	R.P.M	CFM (L/min)	PSI (bar)	Inch (mm)	HP	LBS(kg)	Inch	dBA	m/s <sup>2</sup>	
QP-223	3"(76)	5500	2.2(62)	90(6.3)	5-1/8"(130)	0.38	1.3 0.6	3/8"	74.0	0.9	5/16"-24

# AUTO REPAIR TOOL



## QE-323N [SET]

**1/4" AIR REVERSIBLE DRILL**

Air inlet : 1/4"

### Contents:

- + 1 pc 3.5mm Drill Bits
- + 1 pc 4.0mm Drill Bits
- + 1 pc 4.5mm Drill Bits
- + 1 pc 5.0mm Drill Bits
- + 1 pc 5.5mm Drill Bits
- + 1 pc Key Wrench
- + 1 pc 1/4" Plug
- + 1 pc Oil Box
- + 1 pc Air Reversible Drill(QE-323)



**QE-323**



	Chuck Size	Free Speed	Motor	Avg. Air Consumption	Air Pressure	Overall Length	Net Weight	Air Hose	Sound Pressure	Vibration Level
	inch/mm	R.P.M	hp	CFM (L/min)	PSI (bar)	Inch (mm)	LBS kg	Inch	dBA	m/s <sup>2</sup>
<b>QE-323</b>	1/4" (6.35)	1600	0.38	1.9(154)	90(6.3)	6-15/32"(164)	1.7 0.78	3/8"	74.0	1.2



## RA-505N [SET]

**Air Screwdriver**

Twin Dog Type Air inlet : 1/4"  
Screw Capacity : M5

### Contents:

- + 1 pcs Air Screwdriver
- + 2 pcs Bits FD(L:50mm)
- + 2 pcs Bits PH2(L:65mm)
- + 1 pcs Bits PH2(L:100mm)
- + 1 pc 1/4" Plug
- + 1 pc Oil Box



**RA-505**



	Chuck Size	Torque Range	Free Speed	Avg. Air Consumption	Air Pressure	Overall Length	Net Weight	Air Hose	Sound Pressure	Vibration Level
	inch(mm)	FT-LB(Nm)	R.P.M	CFM (L/min)	PSI (bar)	Inch (mm)	LBS kg	Inch	dBA	m/s <sup>2</sup>
<b>RA-505</b>	1/4" (6.35)	5-45 (6-61)	11000	1.8 (51)	90(6.3)	6-5/16"(161)	1.54 0.7	3/8"	74.0	3.3



## QT-102

**AIR TYRE BUFFER**

Air inlet : 1/4"



## QT-203 / QT-113

**AIR TYRE BUFFER / QUICK CHANGE CHUCK**

Air inlet : 1/4"



	Chuck Size	Collet Size	Free Speed	Avg. Air Consumption	Air Pressure	Overall Length	Motor	Net Weight	Air Hose	Sound Pressure	Vibration Level
	inch(mm)	inch(mm)	R.P.M	CFM (L/min)	PSI (bar)	Inch (mm)	hp	LBS(kg)	Inch	dBA	m/s <sup>2</sup>
<b>QT-102</b>	---	1/4" (6)	7500	3.0 (85)	90(6.3)	5-1/2"(140)	0.3	0.9 0.41	3/8"	77.0	1.3
<b>QT-203</b>	Hex.7/16"(11.1)	---	4000	10.6 (300)	90(6.3)	9-3/4"(250)	0.5	1.76 0.80	3/8"	75.0	0.87
<b>QT-113</b>	Hex.7/16"(11.1)	---	2500	10.6 (300)	90(6.3)	9-3/4"(250)	0.5	1.76 0.80	3/8"	75.0	0.87

★★   
**QM-1125**  
**PNEUMATIC CV JOINT**  
**BOOTS FITTING TOOL**



Capacity	Max Air Pressure	Air Pressure	Overall Length	Net Weight	Air Hose	
Inch (mm)	PSI (bar)	PSI (bar)	Inch (mm)	LBS(kg)	Inch	
QM-1125	1"-4-3/8"(25-110)	125(8.6)	90(6.3)	17-3/8"(442)	7.15 3.25	3/8"

★★   
**QB-0808**  
**QB-0808U For USA**  
**AIR SURFACE-CLEANING TOOL**  
 Air inlet : 1/4"

- Air Surface-Cleaning Tool:1pc(QB-802)
- Eraser Wheel:1pc
- Stripping Wheel:1pc
- Wire Wheel(Coarse):1pc
- Wire Wheel:1pcs
- Allen Key 6mm:1pc
- Spanner Wrench:1pc
- 1/4" Plug:1pc
- Adapter Male UNF 5/16"-24
- Female M6x1.0:1pc



QB-9415 QB-9414  
 QB-9414U For USA



★★   
**QB-812 / QB-812U For USA**  
**Air Eraser** Air inlet : 1/4"



★★   
**QB-802 / QB-802U For USA**  
**AIR SURFACE-CLEANING TOOL** Air inlet : 1/4"



Free Speed	Avg. Air Consumption	Air Pressure	Overall Length	Motor	Net Weight	Air Hose	Sound Pressure	Vibration Level	
R.P.M	CFM (L/min)	PSI (bar)	Inch (mm)	HP	LBS kg	Inch	dBA	m/s <sup>2</sup>	
				<b>hp</b>					
QB-802	3600	10.6(300)	90(6.3)	7-7/8"(200)	0.7	2.6 1.2	3/8"	86	0.3
QB-812	4000	10.0(283)	90(6.3)	8-7/8"(225)	0.5	1.7 0.8	3/8"	75	0.87

**SK-1131**  
**AIR CAULKING GUN**



**SK-1010**  
**AIR CAULKING GUN**



Avg. Air Consumption	Air Pressure	Overall Length	Net Weight	Air Hose	
CFM (L/min)	PSI (bar)	Inch (mm)	LBS kg	Inch	
SK-1010	4.0(113)	50~70(3.4~4.8)	12" (305)	2.4 1.1	3/8"
SK-1131	4.0(113)	60~90(4.1~6.2)	24-7/16" (620)	2.66 1.21	3/8"

★★   
**SM-111R**  
**AIR DENT PULLER**  
 Air inlet : 1/4"



Pad Dia	Exhaust System	Maximum Pulling Force	Air Pressure	Avg. Air Consumption	Net Weight	Slide Hammer Weight	Overall Length	
Inch(mm)		Kg	PSI (bar)	CFM (L/min)	LBS kg	LBS kg	Inch (mm)	
SM-111R	3",4.5",6"(78,115,155)	Rear	90-100	90 (6.3)	8.5(240)	6.0 2.75	3.5 1.6	44-1/8"(1120)

# AUTO REPAIR TOOL

AUTO REPAIR TOOL

**SB-3030**

Air inlet : 1/4"



**SB-3038**

Air inlet : 1/4"



**SB-4031** Short Piping

**SB-4151** Long Piping

150 cm

**ONE TOUCH**

Air inlet : 1/4"

Dial Face Size : Ø3.5"



**SB-2031** Short Piping

**SB-2131** Long Piping

100 cm

**ONE TOUCH**

Air inlet : 1/4"

Dial Face Size : Ø3.5"



**SB-422**

**TYRE INFLATOR**

Air inlet : 1/4"



**SB-423**

**TYRE INFLATOR**

Air inlet : 1/4"



**SB-201**

**DIGITAL TYRE INFLATOR**

Air inlet : 1/4"



**SB-215**

**DIGITAL TYRE INFLATOR**

Air inlet : 1/4"



**SB-710**

**TYRE INFLATOR**

**Tyre Valve Clip**

Air Inlet : 1/4"



**SB-501**

**Tyre Inflator**

Air Inlet : 1/4"



	Max Pressure PSI (bar)	Air Consumption at 100PSI CFM	Air Inlet Inch	Air Pressure PSI (bar)	Net Weight LBS	kg	Air Hose Inch	Nozzle Length cm	Nozzle
	MAX								
SB-2031	160(11.0)	1.41	1/4"	90(6.3)	1.32	0.6	3/8"	30	One touch clip
SB-2131	160(11.0)	1.41	1/4"	90(6.3)	1.43	0.65	3/8"	150	One touch clip
SB-3030	200(14.0)	1.41	1/4"	90(6.3)	1.08	0.49	3/8"	30	Tyre valve clip
SB-3038	200(14.0)	1.41	1/4"	90(6.3)	1.49	0.68	3/8"	100	Tyre valve clip
SB-4031	160(11.0)	1.41	1/4"	90(6.3)	1.32	0.6	3/8"	30	One touch clip
SB-4151	160(11.0)	1.41	1/4"	90(6.3)	1.43	0.65	3/8"	150	One touch clip
SB-6042	160(11.0)	1.41	1/4"	90(6.3)	1.36	0.62	3/8"	100	Tyre valve clip
SB-201	160(11.0)	1.41	1/4"	90(6.3)	0.70	0.32	3/8"	30	Tyre valve clip
SB-215	160(11.0)	1.41	1/4"	90(6.3)	0.88	0.40	3/8"	150	Tyre valve clip
SB-422	160(11.0)	1.41	1/4"	90(6.3)	1.21	0.55	3/8"	45	Tyre valve clip
SB-423	220(15.0)	1.41	1/4"	90(6.3)	2.92	1.33	3/8"	100	Tyre valve clip
SB-710	200(13.8)	1.41	1/4"	90(6.3)	1.0	0.5	3/8"	100	Tyre valve clip
SB-501	160(11.0)	1.41	1/4"	90(6.3)	2.92	1.33	3/8"	30	Dual Chuck



**SE-1101**  
LED WORK LAMP  
USB CHARGING AVAILABLE



**SE-1025**  
FLEXIBLE LED LIGHT



**QT-112T**  
AIR TYRE BUFFER  
Air inlet : 1/4"



2pcs Planet Gear with bearing

*Stylized grip*



**QT-203T / QT-303**

2pcs Planet Gear with bearing

AIR TYRE BUFFER / QUICK CHANGE CHUCK  
Air inlet : 1/4"



*Stylized grip*



	Chuck Size inch(mm)	Collet Size inch / mm	Free Speed R.P.M	Avg. Air Consumption CFM (L/min)	Air Pressure PSI (bar)	Overall Length Inch (mm)	Motor hp	Net Weight LBS(kg)	Air Hose Inch	Sound Pressure dBA	Vibration Level m/s <sup>2</sup>
QT-112T	---	1/4" / 6	4000	5.0 (141)	90(6.3)	8-27/32"(225)	0.5	1.72 / 0.78	3/8"	85.0	1.2
QT-203T	Hex.7/16"(11.1)	---	4000	5.0 (141)	90(6.3)	8-27/32"(225)	0.5	1.98 / 0.90	3/8"	85.0	1.6
QT-303	Hex.7/16"(11.1)	---	22000	5.0 (141)	90(6.3)	8-9/16"(217)	0.5	1.74 / 0.79	3/8"	85.0	1.6



**QB-802T**  
**QB-802TU** For USA

AIR ERASER Spindle Size :3/8"-24  
Air inlet : 1/4"



**QB-812T**  
**QB-812TU** For USA

AIR ERASER Spindle Size :3/8"-24  
Air inlet : 1/4"



**QP-415**  
AIR ANGLE POLISHER  
Spindle Size :5/16"-24  
Air inlet : 1/4"



	Free Speed R.P.M	Avg. Air Consumption CFM (L/min)	Air Pressure PSI (bar)	Overall Length Inch (mm)	Motor HP	Net Weight LBS / kg	Air Hose Inch	Sound Pressure dBA	Vibration Level m/s <sup>2</sup>
QB-802T	4000	5.0 (141)	90(6.3)	8-5/32"(212)	0.5	3.08 / 1.40	3/8"	85.0	1.2
QB-812T	4000	5.0 (141)	90(6.3)	8-15/32"(215)	0.5	1.67 / 0.76	3/8"	85.0	1.2

	Pad Dia inch(mm)	Free Speed R.P.M	Avg. Air Consumption CFM (L/min)	Air Pressure PSI (bar)	Overall Length Inch (mm)	Motor HP	Net Weight LBS(kg)	Air Hose Inch	Sound Pressure dBA	Vibration Level m/s <sup>2</sup>
QP-415	5"(127)	2500	5.0(141)	90(6.3)	8-11/32"(211)	0.5	2.5 / 1.14	3/8"	85.0	1.1

# AUTO REPAIR TOOL

AUTO REPAIR TOOL

## WG-202N [SET]

**AIR SUCTION & BLOW GUN KIT**  
Air inlet : 1/4"

**CONTENTS:**

- 1 pc Extension Tube
- 1 pc Small Diameter Vacuum Tube
- 1 pc Flat Tube
- 1 pc Brush
- 1 pc Flexible tube
- 1 pc Deflector
- 1 pc Clamping Ring
- 1 pc Dust Bag



WG-202



## SR-2001-KIT

**AIR BRUSH KIT**

**CONTENTS:**

- 1 Airbrush
- 1 22c.c. Glass Jar
- 1 50c.c. Glass Jar
- 1 55FT(M5 x 0.45) Air Hose
- 1 Adaptor
- 1 Holder
- 1 2c.c. Cup
- 1 8c.c. Cup
- 1 Spanner



## SR-2101

**AIR BRUSH SET**

**CONTENTS:**

- Air Brush
- Pipette
- Spanner
- Air Adaptor



## SC-005

**BALL JOINT & TIE-ROD SPLITTER SET**

**CONTENTS:**

- Air Hammer Adapter
- 1-1/8"(28.57mm) Pitman Arm
- Striking Handle
- 11/16"(17.46mm) Tie Rod
- 15/16"(23.81mm) Ball Joint



## SQ-0217

**AIR POWERED BRAKE CALIIPER WIND BACK TOOL-SET 17PCS**

- Air Powered Brake Caliper Wind Back Tool : 1pc
- Disk : 16pcs

**Not available in north America**



## SM-0813

**Manual & Fluid Extractor**



## SM-0911

**Manual & Pneumatic Fluid Extractor**



## SM-0503

**Pneumatic Brake Extractor & Refilled KIT**



	Air Pressure	Net Weight		Capacity
	PSI	LB	KG	L
SM-0813	70 -170	6.80	2.7	8.0
SM-0911	70 -170	6.80	3.1	9.5
SM-0503	70 -170	4.12	1.86	3.0

# SANDBLASTING GUN

**SX-3103**  
AIR SANDBLASTING GUN



**SX-3101**  
AIR SANDBLASTING GUN



**SX-2101**  
AIR TWISTER GUN  
Not available in north America



**SX-3203**  
1L AIR CLEANING GUN



**SX-3111**  
AIR UNDERSEAL GUN



**SX-3102**  
AIR SANDBLASTING GUN



**SX-4101**  
SODA BLASTER



**SX-1615**  
AIR CLEANING GUN



**SX-3112**  
AIR UNDERSEAL GUN



**SX-3301**  
AIR SOLVENT  
CLEANER SPRAY GUN



	Cup Capacity L	Free Speed R.P.M	Avg. Air Consumption CFM (L/min)	Air Pressure PSI (bar)	Overall Length Inch (mm)	Net Weight LBS(kg)	Air Hose Inch	Sound Pressure dBA	
SX-3101	1.0	----	4.3 (121.8)	90(6.3)	11" (280)	1.26	0.57	3/8"	85.0
SX-3102	0.7	----	4.0 (113.3)	90(6.3)	10-1/8" (260)	0.77	0.35	3/8"	85.0
SX-3103	----	----	3.5 (99.1)	90(6.3)	122" (3100)	2.31	10.5	3/8"	80.0
SX-3111	1.0	----	3.0 (84.9)	90(6.3)	10-1/8" (260)	0.97	0.44	3/8"	85.0
SX-3112	----	----	3.0 (84.9)	90(6.3)	10-1/8" (260)	0.48	0.22	3/8"	85.0
SX-1615	1.0	----	5.0 (141.5)	90(6.3)	11-7/16" (290)	0.9	0.4	3/8"	85.0
SX-2101	1.0	5500	2.0 (56.6)	90(6.3)	8-7/32*4-5/16"	1.71	0.78	3/8"	85.0
SX-3301	1.0	----	10 (300)	90(6.3)	11-13/16"(300)	1.52	0.69	1/4"	----
SX-3203	1.0	----	1.0 (28.3)	90(6.3)	18-1/2" (470)	1.17	0.53	3/8"	65.0
SX-4101	0.6	----	8.0(226.5)	90(6.3)	7-3/4" (197)	0.8	0.36	3/8"	82.0

# FILTER REGULATOR LUBRICATOR

FILTER REGULATOR LUBRICATOR

## SV-1240

FILTER,REGULATOR  
Air inlet : 1/4"



## SV-2230/2330

FILTER,REGULATOR,LUBRICATOR  
Air inlet : 1/4" / 3/8"



## SV-2220

FILTER,REGULATOR,LUBRICATOR  
Air inlet : 1/4"



## SV-1260

FILTER,REGULATOR  
Air inlet : 1/4"

## SV-1360

FILTER,REGULATOR  
Air inlet : 3/8"



## SV-2431

FILTER,REGULATOR,LUBRICATOR  
Air inlet : 1/2"



## SV-2260 /2280

FILTER,REGULATOR,LUBRICATOR  
Air inlet : 1/4"

## SV-2360 /2380

FILTER,REGULATOR,LUBRICATOR  
Air inlet : 3/8"



## SV-3260 / 3360

FILTER,REGULATOR,LUBRICATOR  
Air inlet : 1/4" , 3/8"



## SV-3460

FILTER,REGULATOR,LUBRICATOR  
Air inlet : 1/2"



## SV-1460

FILTER,REGULATOR,LUBRICATOR  
Air inlet : 1/2"



## SV-2460

FILTER,REGULATOR,LUBRICATOR  
Air inlet : 1/2"





## SV-1660

FILTER,REGULATOR,LUBRICATOR  
Air inlet : 3/4"



## SV-1860

FILTER,REGULATOR,LUBRICATOR  
Air inlet : 1"

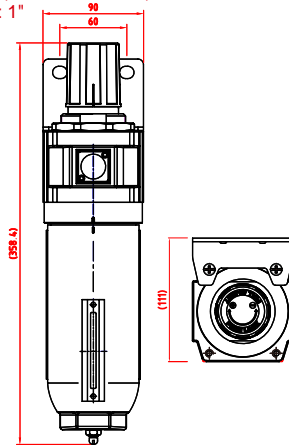

## SV-2660/2860

FILTER,REGULATOR,LUBRICATOR  
Air inlet : 3/4" / 1"



## SV-3660/3860

FILTER,REGULATOR,LUBRICATOR  
Air inlet : 3/4" / 1"



## SW-12(1/4")

## SW-13(3/8")

Mini Lubricator



	Air in / outlet inch	Max Input Pressure PSI	Max Output Pressure PSI	Max.Flow L/min	Working Temperature °C	Drain Capacity ml	Oil Capacity ml	Filter Element μ (micro)
	—	—	—	—	Working	—	—	
SV-1240	1/4"	150	145	1100	5~60°	15	----	5μ
SV-2230	1/4"	215	70-140	1100	5~60°	30	55	5μ
SV-2330	3/8"	215	70-140	1100	5~60°	30	55	5μ
SV-2220	1/4"	150	70-140	1100	5~60°	15	30	5μ
SV-1260	1/4"	215	145	1750	5~60°	80	----	5μ
SV-1360	3/8"	215	145	2500	5~60°	80	----	5μ
SV-2431	1/2"	285	70-140	3400	5~60°	80	200	40μ
SV-2260/2360	1/4" / 3/8"	215	70-150	1750 / 2500	5~60°	80	150	5μ
SV-2280/2380	1/4" / 3/8"	250	70-140	1750 / 2500	5~60°	80	150	5μ
SV-3260/3360	1/4" / 3/8"	215	70-150	1750 / 2500	5~60°	80	150	5μ
SV-3460	1/2"	250	7-215	4000	5~60°	80	150	5μ
SV-1460	1/2"	215	145	3000	5~60°	80	----	5μ
SV-2460	1/2"	250	7-215	4000	5~60°	80	150	5μ
SV-1660	3/4"	250	225	4600	5~60°	300	----	5μ
SV-1860	1"	250	225	5200	5~60°	300	----	5μ
SV-2660/2860	3/4" / 1"	250	225	4600 / 5200	5~60°	300	300	5μ
SV-3660/3860	3/4" / 1"	250	225	4600 / 5200	5~60°	300	350	5μ

# AIR HOSE REEL

## SA-2015

### AIR HOSE REEL

Case Material : Steel  
Air inlet : 1/4" - Male



## SA-3215 SA-3315

### AIR HOSE REEL

Case Material : Shock-proof plastic  
Air inlet : 1/4" - Male



## SD-23/SD-24

### POLYURETHANE RECOIL AIR-HOSE

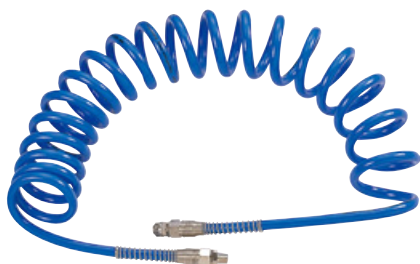

## SD-22

### 8 X 12 AIR HOSE



	Hose Inside Diameter mm	Hose outside Diameter mm	Hose Length M	Working Pressure PSI(bar)	Maximum Pressure PSI(bar)	Male PT Fitting inch	Weight kg
SA-2015	8.0	12.0	15	101.5 (7.0)	284.4(17.8)	1/4"	6.2
SA-3215	8.0	12.0	15	90 (6.3)	300(20.7)	1/4"	5.0
SA-3315	10.0	15.0	15	90 (6.3)	300(20.7)	3/8"	6.0
SD-22107	8.0	12.0	7.5	101.5 (7.0)	284.4(17.8)	1/4"	0.8
SD-22115	8.0	12.0	15	101.5 (7.0)	284.4(17.8)	1/4"	1.4
SD-22130	8.0	12.0	30	101.5 (7.0)	284.4(17.8)	1/4"	2.6
SD-23110	8.0	12.0	10	101.5 (7.0)	284.4(17.8)	1/4"	0.8
SD-23115	8.0	12.0	15	101.5 (7.0)	284.4(17.8)	1/4"	1.2
SD-23210	5.0	8.0	10	101.5 (7.0)	284.4(17.8)	1/4"	0.4
SD-23215	5.0	8.0	15	101.5 (7.0)	284.4(17.8)	1/4"	0.6
SD-23315	10	15.0	15	101.5 (7.0)	284.4(17.8)	3/8"	1.9
SD-24415	13	18.0	15	101.5 (7.0)	284.4(17.8)	1/2"	2.1

# TORQUE WRENCH

## ★★★ TE-81N / TE-82N TE-83N / TE-84N / TE-85N

1" Torque Wrench, Engrave. Nm / ft-lb scale  
Accuracy of torque +/- 3%



	Drive	Torque Range	Torque Range	Indicator	Torque Adjusting	D	H	L	Weight
	inch	(Nm)	(ft-lb)			mm	mm	mm	kg
TE-815080N	1"	150~800	129~572	Engraved	Rotating	---	---	1240	6.1
TE-820100N	1"	200~1000	166~719	Engraved	Rotating	70.2	72.1	1240	6.4
TE-830150N	1"	300~1500	258~1070	Engraved	Rotating	---	---	1850	10.6
TE-840200N	1"	400~2000	369~1402	Engraved	Rotating	---	---	2300	18.3
TE-850250N	1"	500~2500	443~1771	Engraved	Rotating	74.5	66.1	2755	19.6

## ★★★ TM-0416 TM-0418

TORQUE MULTIPLIER



- Works with high transmission efficiency by planet gears
- 5:1 torque multiplication
- Multiplication accuracy ±5%
- Supplied with 2 reaction bar styles

## ★★★ TM-0428-1 TM-0428-2

TORQUE MULTIPLIER



- Multiplication deviation less than ±5%
- Mechanism with high ratio gearbox 26:1
- High ratios offer benefits without using long lever arms or heavy wrenches
- Supplied with 2 different reaction bar
- Durable construction without maintenance necessary and long lifetime

	Input Square	Output Square	Max Rated Output	Ratio	Net Weight	
	Inch	Inch	FT-LB(Nm)		LBS	kg
TM-0416	1/2"	3/4"	1100(1500)	5 : 1	14.2	6.48
TM-0418	1/2"	1"	1100(1500)	5 : 1	14.2	6.48
TM-0428-1	1/2"	1"	2200(3000)	15.5 : 1	25.4	11.5
TM-0428-2	1/2"	1"	3300(4500)	26 : 1	28.7	13

## ★★★ ADJUSTABLE TORQUE WRENCH

1/2" TORQUE WRENCH, Window display. Nm / ft-lb scale, Back Turning

**TW-402102N / TW-404202N / TW-406302N / TW-408402N**

3/4" TORQUE WRENCH, Window display. Nm / ft-lb scale, Back Turning

**TW-611552N / TW-615752N**

Accuracy of torque +/- 4% DIN ISO-6789 AMSE B107.14-2004



## ★★★ Professional Series Torque Wrench

Window display. Nm / ft-lb scale, Back Turning

**TW-210222 / TW-310552 / TW-411102 / TW-412202**

Accuracy of torque +/- 3%



# TORQUE WRENCH

## ★ Classic Series Torque Wrench

**TE-205025N / TE-225250N / TE-305025N / TE-320110N / TE-442210N  
TE-428210N / TE-450350N**

1/2" Torque Wrench, 42-210Nm, Engrave Nm / ft-lb scale

Accuracy of torque +/- 4% ; Quality meets DIN ISO 6789 & ASME B107.300-2010



## ★ Micro-Adjustable Torque Wrench Series

**TB-205025N / TB-305025N / TB-320110N / TB-420210N / TB-450350N  
TB-610060N / TB-615080N / TB-620100N**

Accuracy of torque +/- 4%



## ★ Professional Reversible Series Torque Wrench

**TD-205025 / TD-305050 / TD-410100 / TD-420200 / TD-610060**

Accuracy of torque +/- 3%



## ★ Professional Series Torque Wrench

3/4" Torque Wrench, Window display, Nm / ft-lb scale, Back Turning

**TW-611602 / TW-611802 / TW-612102**

Accuracy of torque +/- 3%



## ★ Classic Series Torque Wrench

3/8" / 1/2" Drive FLEX-HEAD TORQUE WRENCH

**TF-310080N / TF-430250N**



With  $\pm 15^\circ$  flex. head.



Easy Lock and Adjustment design.



## ★ Split-Beam Series Torque Wrench

3/8" / 1/2" Drive FLEXIBLE SPLIT-BEAM TORQUE WRENCH

**TS-320100N / TS-440250N**



With  $\pm 15^\circ$  flex. head.



Open the hinge cover, adjust setting by knob



	Drive	Torque Range (Nm)	Torque Range (ft-lb)	Torque Range (in-lb)	Indicator	Torque Adjusting	D mm	H mm	L mm	Weight kg
TW-402102N	1/2"	20-100	15-75	---	Magnifying glass	Back Turning	40.5	40	405	1.02
TW-404202N	1/2"	40-200	30-150	---	Magnifying glass	Back Turning	40.5	40	500	1.20
TW-406302N	1/2"	60-300	45-200	---	Magnifying glass	Back Turning	40.5	40	595	1.33
TW-408401N	1/2"	80-400	60-300	---	Magnifying glass	Back Turning	40.5	40	680	1.82
TW-611552N	3/4"	110-550	75-405	---	Magnifying glass	Back Turning	63.0	58	970	3.70
TW-615752N	3/4"	150-750	112.5-555	---	Magnifying glass	Back Turning	63.0	58	1150	5.60
TW-210222	1/4"	2-25	1.5-18	---	Magnifying glass	Back Turning	28.0	23	296	0.41
TW-310552	3/8"	5-50	3.5-37	---	Magnifying glass	Back Turning	28.0	28	333	0.47
TW-411102	1/2"	10-100	8-75	---	Magnifying glass	Back Turning	40.5	40	400	0.82
TW-412202	1/2"	20-200	10-150	---	Magnifying glass	Back Turning	40.5	40	500	1.3
TE-205025N	1/2"	5-25	---	53.1-212.4	Engrave	Rotating	32	31.8	275	0.59
TE-225250N	1/4"	2.8-28.2	---	25-250	Engrave	Rotating	32	31.8	275	0.59
TE-305025N	3/8"	5-25	---	53.1-212.4	Engrave	Rotating	32	31.8	370	0.83
TE-320110N	3/8"	20-110	14.8-81.1	---	Engrave	Rotating	32	31.8	370	0.83
TE-442210N	1/2"	42-210	30.6-155	---	Engrave	Rotating	46.3	33	450	1.32
TE-428210N	1/2"	28-210	20.7-154.9	---	Engrave	Rotating	46.3	33	570	1.65
TE-450350N	1/2"	50-350	36.9-258.1	---	Engrave	Rotating	46.3	33	450	1.31
TB-205025N	1/4"	5-25	---	53.1-212.4	Engrave	Rotating	32	31.8	281	0.53
TB-305025N	3/8"	5-25	---	53.1-212.4	Engrave	Rotating	32	31.8	361	0.77
TB-320110N	3/8"	20-110	18.5-77.5	---	Engrave	Rotating	32	31.8	361	0.77
TB-420210N	1/2"	20-210	18.4-151.2	---	Engrave	Rotating	40.5	40	461	1.25
TB-450350N	1/2"	50-350	48.0-247.2	---	Engrave	Rotating	40.5	40	553	1.59
TB-610060N	3/4"	100-600	92.0-424	---	Engrave	Rotating	63	58	1010	2.41
TB-615080N	3/4"	150-800	129-572	---	Engrave	Rotating	63	58	1010	2.41
TB-620100N	3/4"	200-1000	166-719	---	Engrave	Rotating	63	58	1010	2.41
TD-202025	1/4"	2-25	---	53.1-212.4	Magnifying glass	Back Turning	40.5	40	296	0.41
TD-305050	3/8"	5-50	3.5-36.9	---	Magnifying glass	Back Turning	40.5	40	333	0.47
TD-410100	1/2"	10-100	8-75	---	Magnifying glass	Back Turning	40.5	40	445	1.1
TD-420200	1/2"	20-200	10-150	---	Magnifying glass	Back Turning	40.5	40	513	1.28
TD-610060	3/4"	100-600	75-440	---	Magnifying glass	Back Turning	40.5	40	1040	4.65
TW-611602	3/4"	100-600	75-440	---	Magnifying glass	Back Turning	63	58.5	1040	4.65
TW-611802	3/4"	150-800	110-590	---	Magnifying glass	Back Turning	63	58.5	1240	5.45
TW-612102	3/4"	200-1000	150-740	---	Magnifying glass	Back Turning	63	58.5	1240	5.45

	Drive	Torque Range (Nm)	Torque Range (ft-lb)	Indicator	Torque Adjusting	D mm	H mm	L mm	Weight kg
TF-310080N	1/2"	---	10-80	Engrave	Rotating	36.8	30.4	465	1.11
TF-430250N	1/2"	---	30-250	Engrave	Rotating	43.3	40.5	640	1.94

	Drive	Torque Range (Nm)	Torque Range (ft-lb)	Indicator	Torque Adjusting	D mm	H mm	L mm	Weight kg
TS-320100N	3/8"	---	20-100	Engrave	Flexible	35.2	27.8	476	0.95
TS-440250N	3/8"	---	40-250	Engrave	Flexible	44.1	36.1	590	1.7

# DIGITAL TORQUE WRENCH

NEW PRODUCT



★★     **GTF-203030**

1/4" Digital Flexible Torque Wrench





Accuracy: clockwise +/- 2% counterclockwise +/- 3%



★★     **GTF-313135**

3/8" Digital Flexible Torque Wrench

Accuracy: clockwise +/- 2% counterclockwise +/- 3%

★★     **GTF-420200 / GTF-434340**

1/2" Digital Flexible Torque Wrench

Accuracy: clockwise +/- 2% counterclockwise +/- 3%



★★     **GTA-201030**

1/4" Digital Angle Torque Wrench





Accuracy: clockwise +/- 1.5% counterclockwise +/- 2.5%



★★     **GTA-306135**

3/8" Digital Angle Torque Wrench

Accuracy: clockwise +/- 1.5% counterclockwise +/- 2.5%

★★     **GTA-406135 / GTA-410200**

1/2" Digital Angle Torque Wrench

Accuracy: clockwise +/- 1.5% counterclockwise +/- 2.5%





★★     **GTA-417340**

1/2" Digital Angle Torque Wrench

Accuracy: clockwise +/- 1.5% counterclockwise +/- 2.5%



★★     **GTA-606060 / GTA-610100**

3/4" Digital Angle Torque Wrench

Accuracy: clockwise +/- 1.5% counterclockwise +/- 2.5%



★★     **GTA-810100**

1" Digital Angle Torque Wrench

Accuracy: clockwise +/- 1.5% counterclockwise +/- 2.5%



★★     **GTB-201030**

1/4" Digital Flexible & Angle Torque Wrench

Accuracy: clockwise +/- 2% counterclockwise +/- 3%







★★     **GTB-306135**

3/8" Digital Flexible & Angle Torque Wrench

Accuracy: clockwise +/- 2% counterclockwise +/- 3%

DIGITAL TORQUE WRENCH

★★     **GTB-410200 / GTB-417340**

1/2" Digital Flexible Torque Wrench

Accuracy:clockwise +/- 2% counterclockwise +/- 3%





★★     **GMS-203006 / GMS-207015 / GMS-212025**

1/4" Mini Digital Torque Wrench (square)

Accuracy:clockwise +/- 3% counterclockwise +/- 4%



★★     **GMH-203006 / GMH-212025**

1/4" Mini Digital Torque Wrench (Bit)

Accuracy:clockwise +/- 3% counterclockwise +/- 4%



★★     **GMH-207015**

1/4" Mini Digital Torque Wrench (Bit)

Accuracy:clockwise +/- 3% counterclockwise +/- 4%



★★     **GMI-206006 / GMI-215015 / GMI-225025**

1/4" Mini Digital Interchangeable Torque Wrench

Accuracy:clockwise +/- 3% counterclockwise +/- 4%



	Drive	Torque Range (Nm)	Torque Range (ft-lb)	Indicator	Torque Adjusting	D mm	H mm	L mm	Weight kg
GTF-203030	1/4"	3-30	2.2-22.13	LCD	Digital	38	38	446	0.74
GTF-313135	3/8"	13.5-135	10-99.6	LCD	Digital	38	38	446	0.9
GTF-420200	1/2"	20-200	14.8-147.5	LCD	Digital	38	41	572	1.312
GTF-434340	1/2"	34-340	25-250.8	LCD	Digital	38	41	670	1.442
GTA-201030	1/4"	1.5-30	1.11-22.13	LCD	Digital	38	38	410	0.71
GTA-306135	3/8"	6.8-135	5.0-99.6	LCD	Digital	38	38	432	0.84
GTA-406135	1/2"	6.8-135	5.0-99.6	LCD	Digital	38	41	296	0.41
GTA-410200	1/2"	10-200	7.4-147.5	LCD	Digital	38	41	566	1.2
GTA-417340	1/2"	17-340	12.5-250.8	LCD	Digital	38	41	622	1.4
GTA-606060	3/4"	60-600	44.3-442.5	LCD	Digital	63	58	943	3.8
GTA-610100	3/4"	100-1000	73.8-737.6	LCD	Digital	63	58	1235	4.6
GTA-810100	1"	100-1000	73.8-737.6	LCD	Digital	69.3	70	1235	4.9
GTB-201030	1/4"	3-30	2.22-22.13	LCD	Digital	38	38	413	0.74
GTB-306135	3/8"	13.5-135	10-99.6	LCD	Digital	38	38	446	0.9
GTB-410200	1/2"	20-200	14.8-174.5	LCD	Digital	38	41	572	1.3
GTB-417340	1/2"	34-340	25-250	LCD	Digital	38	41	670	1.4
GMS-203006	1/4"	0.3-6	2.7-53.1	LCD	Digital	27	27	243	0.19
GMS-207015	1/4"	0.75-15	6.6-132.8	LCD	Digital	27	27	243	0.19
GMS-212025	1/4"	1.25-25	11.1-221.3	LCD	Digital	27	27	243	0.19
GMH-203006	1/4"	0.3-6	2.7-53.1	LCD	Digital	27	27	243	0.19
GMH-207015	1/4"	0.75-15	6.6-132.8	LCD	Digital	27	27	243	0.19
GMH-212025	1/4"	1.25-25	11.1-221.3	LCD	Digital	27	27	243	0.19
GMI-203006	1/4"	0.6-6	5.3-53	LCD	Digital	27	27	243	2.5
GMI-215015	1/4"	1.5-15	13.26-132.8	LCD	Digital	27	27	243	2.5
GMI-225025	1/4"	2.5-25	22.14-221.3	LCD	Digital	27	27	243	2.5

DIGITAL TORQUE WRENCH

# DIGITAL TORQUE WRENCH

NEW PRODUCT

★★  GTW-201030

1/4" Digital Torque Wrench

Accuracy: clockwise +/- 1.5% counterclockwise +/- 2.5%



★★  GTW-306135

3/8" Digital Torque Wrench

Accuracy: clockwise +/- 1.5% counterclockwise +/- 2.5%



★★  GTW-406135 / GTW-410200

1/2" Digital Torque Wrench

Accuracy: clockwise +/- 1.5% counterclockwise +/- 2.5%



★★  GTW-417340

1/2" Digital Torque Wrench

Accuracy: clockwise +/- 1.5% counterclockwise +/- 2.5%



★★  GTW-606060

3/4" Digital Torque Wrench

Accuracy: clockwise +/- 1.5% counterclockwise +/- 2.5%



★★  GTW-610100 / GTW-810100

3/4" / 1" Digital Torque Wrench

Accuracy: clockwise +/- 1.5% counterclockwise +/- 2.5%



★★  GTW-930 / GTW-940 / GTW-941

3/8" / 1/2" / 1/2" Digital Torque Wrench

Accuracy: clockwise +/- 1.5% counterclockwise +/- 2.5%



	Drive	Torque Range (Nm)	Torque Range (ft-lb)	Indicator	Torque Adjusting	D mm	H mm	L mm	Weight kg
GTW-201030	1/4"	1.5-30	1.11-22.13	LCD	Digital	38	38	410	0.71
GTW-306135	3/8"	6.8-135	5.0-99.6	LCD	Digital	38	38	432	0.84
GTW-406135	1/2"	6.8-135	5.0-99.6	LCD	Digital	38	41	455	1.07
GTW-410200	1/2"	34-340	20.7-154.9	LCD	Digital	38	41	566	1.2
GTW-417340	1/2"	17-340	12.5-250.8	LCD	Digital	38	41	662	1.4
GTW-606060	3/4"	60-600	44.3-442.5	LCD	Digital	63	58	943	3.8
GTW-610100	3/4"	100-1000	73.8-737.6	LCD	Digital	63	58	1235	4.6
GTW-810100	1"	100-1000	73.8-737.6	LCD	Digital	69.5	70	1235	4.9
GTW-930	3/8"	6.8-135	5.0-99.6	LCD	Digital	32	31.8	361	0.77
GTW-940	1/2"	10-200	7.4-147.5	LCD	Digital	32	31.8	361	0.77
GTW-941	1/2"	17-340	12.5-250.8	LCD	Digital	32	31.8	361	0.77

DIGITAL TORQUE WRENCH



# IMPACT SOCKET

## MB34012S

**Impact Socket Set**  
12pcs 3/8" Drive Inch Size

**Contents :** 5/16", 3/8", 7/16", 1/2", 9/16", 5/8", 11/16", 3/4", 13/16", 7/8", 15/16", 1"



## MB34013M

**Impact Socket Set**  
13pcs 3/8" Drive Metric Size

**Contents :** 6mm, 8mm, 9mm, 10mm, 11mm, 12mm, 13mm, 14mm, 15mm, 16mm, 17mm, 18mm, 19mm



## MB35012S

**Deep Impact Socket Set**  
12pcs 3/8" Drive Inch Size

**Contents :** 5/16", 3/8", 7/16", 1/2", 9/16", 5/8", 11/16", 3/4", 13/16", 7/8", 15/16", 1"



## MB35013M

**Deep Impact Socket Set**  
13pcs 3/8" Drive Metric Size

**Contents :** 6mm, 8mm, 9mm, 10mm, 11mm, 12mm, 13mm, 14mm, 15mm, 16mm, 17mm, 18mm, 19mm



## MB43015M

**Deep Impact Socket Set**  
15pcs 1/2" Drive Metric Size

**Contents :** 10mm 11mm 12mm 13mm 14mm 15mm 16mm 17mm 19mm 21mm 22mm 24mm 27mm 30mm 32mm



## MB44013S

**Impact Socket Set**  
13pcs 1/2" Drive Inch Size

**Contents :** 7/16", 1/2", 9/16", 5/8", 11/16", 3/4", 13/16", 7/8", 15/16", 1", 1-1/16", 1-1/8", 1-1/4"



## MB44014M

**Impact Socket Set**  
14pcs 1/2" Drive Metric Size

**Contents :** 10mm, 11mm, 12mm, 13mm, 14mm, 15mm, 16mm, 17mm, 18mm, 19mm, 21mm, 22mm, 26mm, 27mm



## MB45010M

**Deep Impact Socket Set**  
10pcs 1/2" Drive Metric Size

**Contents :** 10mm, 12mm, 13mm, 14mm, 15mm, 17mm, 19mm, 21mm, 24mm, 27mm



## MB45013S

**Deep Impact Socket Set**  
13pcs 1/2" Drive Inch Size

**Contents :** 7/16", 1/2", 9/16", 5/8", 11/16", 3/4", 13/16", 7/8", 15/16", 1", 1-1/16", 1-1/8", 1-1/4"



## MB64008S

**Impact Socket Set**  
8pcs 3/4" Drive Inch Size

**Contents :** 1", 1-5/16", 1-1/16", 1-3/8", 1-1/8", 1-7/16", 1-1/4", 1-1/2"



## MB64008M

**Impact Socket Set**  
8pcs 3/4" Drive Metric Size

**Contents :** 26mm, 27mm, 29mm, 30mm, 32mm, 33mm, 35mm, 36mm



## MB45014M

**Deep Impact Socket Set**  
14pcs 1/2" Drive Metric Size

**Contents :** 10mm, 11mm, 12mm, 13mm, 14mm, 15mm, 16mm, 17mm, 18mm, 19mm, 21mm, 22mm, 26mm, 27mm



# IMPACT SOCKET

## MB64008SP

Impact Socket Set  
8pcs 3/4" Drive Inch Size

Contents : 3/4", 7/8", 15/16", 1-1/16"  
1-3/16", 1-1/4", 1-7/16", 1-1/2"



## MB65008S

Deep Impact Socket Set  
8pcs 3/4" Drive Inch Size

Contents : 1", 1-1/16", 1-1/8", 1-1/4"  
1-5/16", 1-3/8", 1-7/16", 1-1/2"



## MB66006S MB66006M

Impact Hex Driver Set  
6pcs 3/4" SAE 100mm Length

Contents :  
S : 1/2", 9/16", 5/8", 3/4", 7/8", 1"  
M : H12, H14, H17, H19, H22, H24



## MB65008M

Deep Impact Socket Set  
8pcs 3/4" Drive Metric Size

Contents : 26mm, 27mm, 29mm, 30mm  
32mm, 33mm 35mm, 36mm



## MA4550M50

Twist Socket SET (50mm Length)  
5PCS 1/2" Driver

Contents :  
17mm, 19mm, 21mm, 22mm  
Punch Bar  $\varnothing$ 12-80L



## MB44008S

Impact Hex Drive Set  
8pcs 1/2" Drive Inch Size SAE (Length 78mm)

Contents : 1/4", 5/16", 3/8", 7/16", 1/2", 9/16", 5/8", 3/4"



## MB64008M1

Impact Socket Set  
8PCS 3/4" Drive

Contents : 21mm, 23mm, 24mm, 27mm, 30mm,  
32mm, 36mm, 41mm



## MB44008M

Impact Hex Drive Set  
8pcs 1/2" Drive Metric Size SAE (Length 78mm)

Contents : H6, H7, H8, H10, H12, H14, H17, H19



## MB65008S1

Deep Impact Socket Set  
8pcs 3/4" Drive Inch Size

Contents : 3/4", 7/8", 15/16", 1", 1-1/16"  
1-1/8", 1-3/16", 1-1/4"



## NEW PRODUCT

## MB65008M1

Deep Impact Socket Set  
8pcs 3/4" Drive Metric Size

Contents : 21mm, 23mm, 24mm, 27mm  
30mm, 32mm, 36mm, 41mm



## MB46008R

Star Bit Socket Set  
8pcs 1/2" Drive

Contents : T30, T40, T45, T47,  
T50, T55, T60, T70



## MB46010R

Star Bit Socket Set  
10pcs 1/2" Drive

Contents : T20, T25, T27, T30, T40, T45,  
T50, T55, T60, T70



# ME011N

## Impact Adapter Impact Universal Joint

### IMPACT ADAPTER

Contents : 1/4"Fx3/8"M, 3/8"Fx1/4"M, 3/8"Fx1/2"M,  
1/2"Fx3/8"M, 1/2"Fx3/4"M, 3/4"Fx1/2"M, 3/4"Fx1"M,  
1"Fx3/4"M

### IMPACT UNIVERSAL JOINT

Contents : 1/4"Dr, 3/8"Dr, 1/2"Dr



# MA8050

## 5pcs 1" Drive Combination Budd Wheel Impact Socket Set

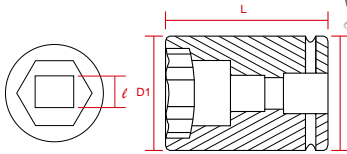

# MA42015M

## 15pcs 1/2" Drive Stubby Metric Size Impact Socket Set



# MA42006M

## 1/2" Drive Stubby Metric Size Impact Socket Set



# MA42006S

## 1/2" Drive Stubby Inch Size Impact Socket Set



# MA4030

## 3pcs 1/2" Drive Deep Impact Socket Set

- Contents : 17mm, 19mm, 21mm By identifying the different color coated, the operator can easily pick up the size needed.
- With the external sheath, the working object can be well protected from being rubbed, scratched, impacted...etc.
- With the 85mm extra long socket, to loosen or tighten bolt or nut in deeper hole become easier and convenient.



**Note:** Impact socket for aluminum rim wheel nuts, with polymeric material insets.

# MA42026

## 26pcs 1/2" Drive Stubby Impact Socket Set

### Contents :

S : 5/16", 3/8", 7/16", 1/2", 9/16", 5/8", 11/16", 3/4", 13/16", 7/8", 15/16"  
M : 10mm, 11mm, 12mm, 13mm, 14mm, 15mm, 16mm, 17mm, 18mm, 19mm, 20mm,  
21mm, 22mm, 23mm, 24mm

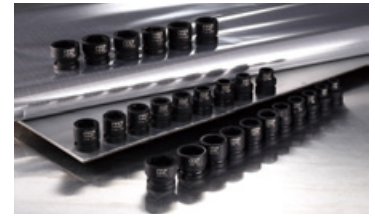

M7 NO.	Hex	D1	D2	L	Weight	Box	
	mm	mm	mm	mm	g		
MA812S4826	1-1/2"	57	57	13/16"	99	1.34	1/1
MA812M3517	35	52	54	17	94	1.10	1/1
MA812M3820	38	54	56	20	96	1.18	1/1
MA812M4121	41	54	58	21	99	1.19	1/1
MA831M33L	33	52	52	90	1.01	1/1	
MA8050	---	---	---	---	6.20	1/4	

M7 NO.	Circle	D1	D2	T	L	Weight	Box
	mm	mm	mm	mm	mm	g	
MA401M10	10	18	25	5	28	50	15/10
MA401M11	11	18	25	5	28	50	15/10
MA401M12	12	19	25	5	28	50	15/10
MA401M13	13	20	25	5	28	52	15/10
MA401M14	14	22	25	5	28	53	15/10
MA401M15	15	23	25	5	28	55	15/10
MA401M16	16	25	25	8	28	62	15/10
MA401M17	17	26	26	8	28	67	15/10
MA401M18	18	28	28	8	28	82	15/10
MA401M19	19	28	28	9	28	75	15/10
MA401M20	20	30	30	9	28	90	15/10
MA401M21	21	30	30	9	28	86	15/10
MA401M22	22	32	30	9	28	94	15/10
MA401M23	23	34	30	9	28	102	15/10
MA401M24	24	34	30	9	28	98	15/10

M7 NO.	Circle	D1	D2	ℓ	L	Weight	Box
	mm	mm	mm	mm	mm	g	
MA401M13	13	20	25	5	28	54	6/40
MA401M17	17	26	26	8	28	70	6/40
MA401M19	19	28	28	9	28	80	6/40
MA401M21	21	30	30	9	28	90	6/40
MA401M22	22	32	30	9	28	100	6/40
MA401M24	34	34	30	9	28	110	6/40

M7 NO.	Circle	D1	D2	ℓ	L	Weight	Box
	mm	mm	mm	mm	mm	g	
MA401S16	1/2"	20	25	5	28	51	6/40
MA401S18	9/16"	22	25	5	28	54	6/40
MA401S20	5/8"	25	25	8	28	61	6/40
MA401S22	11/16"	26	25	8	28	90	6/40
MA401S24	3/4"	28	30	9	28	100	6/40
MA401S28	7/8"	32	30	9	28	95	6/40

# MA4031M85

## 3pcs 1/2" Drive Deep Thin Wall Impact Socket Set



**STRENGTHEN  
STEEL  
SLEEVE**

3PCS 17mm.19mm.21mm





# IMPACT SOCKET

**PROVIDE FULL RANGE  
ALL SERIES HANG TAG.**



IMPACT SOCKET



MALE ADAPTER



IMPACT DEEP SOCKET



UNIVERSAL JOINT



IMPACT HEX BIT



EXTENSION BAR

## 1/4"MA211M

Impact Standard Socket

- 1/4" Drive Standard Length
- 6 Points
- Metric Size

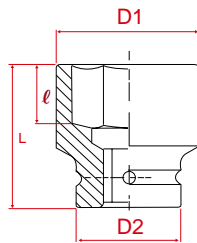

## 1/4"MA211S

Impact Standard Socket

- 1/4" Drive Standard Length
- 6 Points
- Inch Size

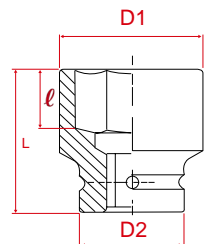

M7 NO.	⊙	D1	D2	l	L	⚖	📦
	mm	mm	mm	mm	mm	g	
MA211M04	4	7.5	13.0	5	23	16	10
MA211M05	5	8.7	13.0	6	23	16	10
MA211M06	6	9.9	13.0	8	23	15	10
MA211M07	7	11.1	13.0	8	23	14	10
MA211M08	8	12.3	13.0	8	23	14	10
MA211M09	9	13.8	13.0	8	23	14	10
MA211M10	10	14.5	13.0	8	23	15	10
MA211M11	11	16.0	13.0	8	23	17	10
MA211M12	12	17.0	13.0	8	23	17	10
MA211M13	13	18.8	13.0	8	23	20	10
MA211M14	14	20.0	13.0	8	23	21	10

M7 NO.	⊙	D1	D2	l	L	⚖	📦
	inch	mm	mm	mm	mm	g	
MA211S06	3/16"	8.4	13.0	6	23	15	10
MA211S07	7/32"	9.4	13.0	6	23	16	10
MA211S08	1/4"	10.3	13.0	8	23	15	10
MA211S09	9/32"	11.3	13.0	8	23	15	10
MA211S10	5/16"	12.3	13.0	8	23	14	10
MA211S11	11/32"	13.8	13.0	8	23	14	10
MA211S12	3/8"	14.5	13.0	8	23	15	10
MA211S14	7/16"	16.0	13.0	8	23	16	10
MA211S16	1/2"	18.8	13.0	8	23	19	10
MA211S18	9/16"	19.8	13.0	8	23	21	10



# 1/4"MA231M

## Impact Deep Socket

- 1/4" Drive Deep Length
- 6 Points
- Metric Size

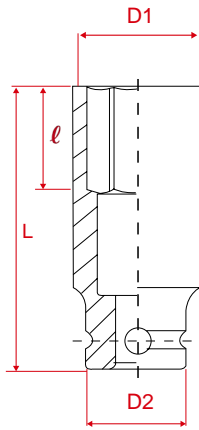

M7 NO.	⌀	D1	D2	l	L	⚖	📦
	mm	mm	mm	mm	mm	g	
MA231M04	4	7.5	13.0	7	50	28	10
MA231M05	5	8.7	13.0	9	50	29	10
MA231M06	6	9.9	13.0	11	50	31	10
MA231M07	7	11.1	13.0	11	50	31	10
MA231M08	8	12.3	13.0	13	50	31	10
MA231M09	9	13.8	13.0	13	50	37	10
MA231M10	10	14.5	13.0	13	50	37	10
MA231M11	11	16.0	13.0	13	50	41	10
MA231M12	12	17.0	13.0	13	50	43	10
MA231M13	13	18.8	13.0	13	50	58	10
MA231M14	14	20.0	13.0	13	50	60	10

# 1/4"MA231S

## Impact Deep Socket

- 1/4" Drive Deep Length
- 6 Points
- Inch Size

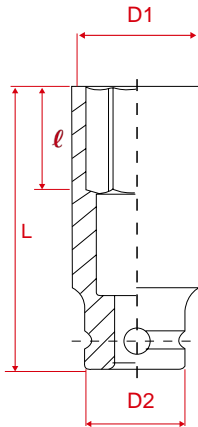

M7 NO.	⌀	D1	D2	l	L	⚖	📦
	inch	mm	mm	mm	mm	g	
MA231S06	3/16"	8.4	13.0	9	50	29	10
MA231S07	7/32"	9.4	13.0	9	50	30	10
MA231S08	1/4"	10.3	13.0	11	50	31	10
MA231S09	9/32"	11.3	13.0	11	50	32	10
MA231S10	5/16"	12.3	13.0	13	50	32	10
MA231S11	11/32"	13.8	13.0	13	50	37	10
MA231S12	3/8"	14.5	13.0	13	50	41	10
MA231S14	7/16"	16.0	13.0	13	50	41	10
MA231S16	1/2"	18.8	13.0	13	50	56	10
MA231S18	9/16"	19.8	13.0	13	50	61	10

# 3/8"MA311M

## Impact Standard Socket

- 3/8" Drive Standard Length
- 6 Points
- Metric Size

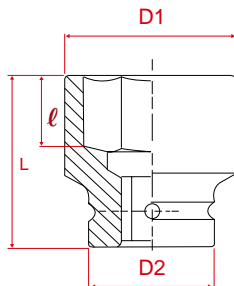

M7 NO.	⌀	D1	D2	l	L	⚖	📦
	mm	mm	mm	mm	mm	g	
MA311M06	6	10.0	19.0	9	29.5	31	10
MA311M07	7	11.4	19.0	9	29.5	31	10
MA311M08	8	12.7	19.0	9	29.5	31	10
MA311M09	9	14.0	19.0	10	29.5	33	10
MA311M10	10	15.2	19.0	10	29.5	33	10
MA311M11	11	17.0	19.0	11	29.5	34	10
MA311M12	12	18.0	19.0	11	29.5	35	10
MA311M13	13	19.0	19.0	11	29.5	36	10
MA311M14	14	20.0	19.0	11	29.5	37	10
MA311M15	15	21.9	19.0	13	29.5	42	10
MA311M16	16	23.5	22.0	13	30.0	57	10
MA311M17	17	25.0	22.0	13	30.0	59	10
MA311M18	18	26.0	22.0	13	30.0	61	10
MA311M19	19	27.0	22.0	15	30.0	63	10
MA311M20	20	28.0	22.0	15	30.0	79	10
MA311M21	21	30.0	22.0	15	30.0	79	10
MA311M22	22	32.0	22.0	15	30.0	98	10
MA311M23	23	33.0	22.0	15	30.0	98	10
MA311M24	24	34.0	22.0	15	30.0	98	10

# 3/8"MA311S

## Impact Standard Socket

- 3/8" Drive Standard Length
- 6 Points
- Inch Size

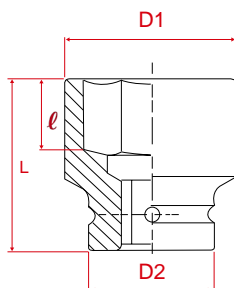

M7 NO.	⌀	D1	D2	l	L	⚖	📦
	inch	mm	mm	mm	mm	g	
MA311S10	5/16"	12.6	19.0	9.0	29.5	31	10
MA311S12	3/8"	14.6	19.0	10.0	29.5	33	10
MA311S14	7/16"	17.1	19.0	11.0	29.5	33	10
MA311S16	1/2"	19.0	19.0	11.0	29.5	37	10
MA311S18	9/16"	20.0	19.0	11.0	29.5	39	10
MA311S20	5/8"	23.5	22.0	13.0	30.0	54	10
MA311S22	11/16"	25.0	22.0	13.0	30.0	56	10
MA311S24	3/4"	27.0	22.0	15.0	30.0	63	10
MA311S26	13/16"	30.0	22.0	15.0	30.0	79	10
MA311S28	7/8"	32.0	22.0	15.0	30.0	87	10
MA311S30	15/16"	34.0	22.0	15.0	30.0	98	10
MA311S32	1"	36.0	22.0	15.0	30.0	100	10

# IMPACT SOCKET

## 3/8"MA331M

Impact Deep Socket

- 3/8" Drive Deep Length
- 6 Points
- Metric Size

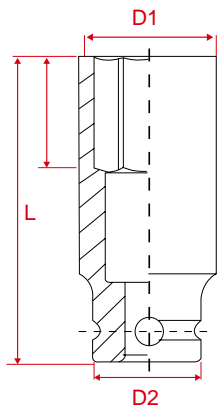

## 3/8"MA331S

Impact Deep Socket

- 3/8" Drive Deep Length
- 6 Points
- Inch Size

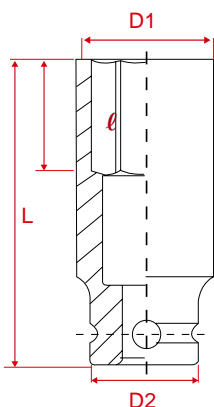

## MA401M

Impact Socket

1/2" Drive Stubby Metric Size

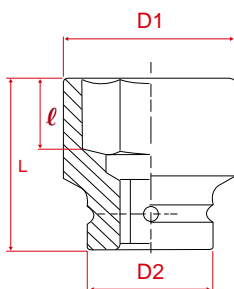

## MA401S

Impact Socket

1/2" Drive Stubby Inch Size

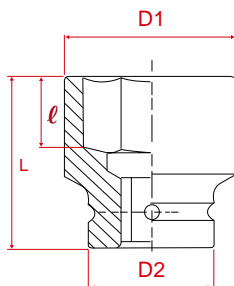

M7 NO.	⊙	D1	D2	ℓ	L	⚖	📦
	mm	mm	mm	mm	mm	g	
MA331M06	6	10.1	19.0	14	63	73	10
MA331M07	7	11.4	19.0	14	63	73	10
MA331M08	8	12.7	19.0	14	63	73	10
MA331M09	9	14.0	19.0	14	63	75	10
MA331M10	10	15.2	19.0	20	63	76	10
MA331M11	11	17.0	19.0	20	63	81	10
MA331M12	12	18.0	19.0	22	63	78	10
MA331M13	13	19.0	19.0	24	63	86	10
MA331M14	14	20.0	19.0	26	63	93	10
MA331M15	15	22.2	19.0	27	63	102	10
MA331M16	16	23.5	22.0	26	63	115	10
MA331M17	17	25.0	22.0	26	63	127	10
MA331M18	18	26.0	22.0	26	63	137	10
MA331M19	19	27.0	22.0	26	63	143	10
MA331M20	20	28.0	22.0	26	63	143	10
MA331M21	21	30.0	22.0	26	63	194	10
MA331M22	22	32.0	22.0	26	63	206	10
MA331M23	23	33.0	22.0	26	63	206	10

M7 NO.	⊙	D1	D2	ℓ	L	⚖	📦
	inch	mm	mm	mm	mm	g	
MA331S08	1/4"	10.5	19.0	4.0	28.5	35	---
MA331S10	5/16"	12.6	19.0	14	63	73	10
MA331S12	3/8"	14.6	19.0	20	63	76	10
MA331S14	7/16"	17.1	19.0	20	63	81	10
MA331S16	1/2"	19.0	19.0	24	63	83	10
MA331S18	9/16"	20.0	19.0	26	63	87	10
MA331S20	5/8"	23.5	22.0	26	63	111	10
MA331S22	11/16"	25.0	22.0	26	63	125	10
MA331S24	3/4"	27.0	22.0	26	63	142	10
MA331S26	13/16"	30.0	22.0	26	63	178	10
MA331S28	7/8"	32.0	22.0	26	63	188	10
MA331S30	15/16"	34.0	22.0	26	63	232	10
MA331S32	1"	36.0	22.0	26	63	249	10

M7 NO.	⊙	D1	D2	ℓ	L	⚖	📦
	mm	mm	mm	mm	mm	g	
MA401M09	09	18	25	5	28	48	6/40
MA401M10	10	18	25	5	28	50	6/40
MA401M11	11	18	25	5	28	50	6/40
MA401M12	12	19	25	5	28	50	6/40
MA401M13	13	20	25	5	28	52	6/40
MA401M14	14	22	25	5	28	53	6/40
MA401M15	15	23	25	5	28	55	6/40
MA401M16	16	25	25	8	28	62	6/40
MA401M17	17	26	26	8	28	67	6/40
MA401M18	18	28	28	8	28	82	6/40
MA401M19	19	28	28	9	28	80	6/40
MA401M20	20	30	30	9	28	90	6/40
MA401M21	21	30	30	9	28	86	6/40
MA401M22	22	32	30	9	28	94	6/40
MA401M23	23	34	30	9	28	102	6/40
MA401M24	24	34	30	9	28	98	6/40

M7 NO.	⊙	D1	D2	ℓ	L	⚖	📦
	inch	mm	mm	mm	mm	g	
MA401S10	5/16"	14.5	25	5	28	46	6/40
MA401S12	3/8"	16	25	5	28	47	6/40
MA401S14	7/16"	18	25	5	28	50	6/40
MA401S16	1/2"	20	25	5	28	51	6/40
MA401S18	9/16"	22	25	5	28	54	6/40
MA401S20	5/8"	25	25	8	28	61	6/40
MA401S26	13/16"	30	30	9	28	88	6/40
MA401S28	7/8"	32	30	9	28	95	6/40
MA401S30	15/16"	34	30	9	28	98	6/40

# 1/2"MA411M

## Impact Standard Socket

- 1/2" Drive Standard Length
- 6 Points
- Metric Size

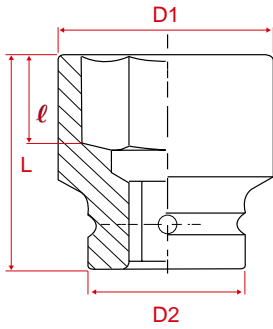

M7 NO.	⊙	D1	D2	ℓ	L	⚖	📦
	mm	mm	mm	mm	mm	g	
MA411M08	8	14.5	24.9	9	38	80	10
MA411M09	9	15.6	24.9	10	38	80	10
MA411M10	10	16.7	24.9	10	38	71	10
MA411M11	11	18.0	24.9	10	38	72	10
MA411M12	12	19.0	24.9	11	38	72	10
MA411M13	13	20.2	24.9	11	38	74	10
MA411M14	14	21.5	24.9	11	38	77	10
MA411M15	15	23.0	24.9	12	38	78	10
MA411M16	16	24.9	24.9	12	38	82	10
MA411M17	17	25.9	25.0	13	38	84	10
MA411M18	18	26.9	25.0	13	38	88	10
MA411M19	19	29.9	25.0	13	38	88	10
MA411M20	20	29.9	25.0	13	38	90	10
MA411M21	21	32.0	30.0	14.5	38	93	10
MA411M22	22	32.0	30.0	14.5	38	134	10
MA411M23	23	34.0	30.0	16	42	138	10
MA411M24	24	36.0	30.0	17	42	138	10
MA411M25	25	36.0	30.0	17	42	150	10
MA411M26	26	38.0	30.0	17	42	158	10
MA411M27	27	40.0	30.0	19	46	159	10
MA411M28	28	38.0	40.0	16	46	270	10
MA411M29	29	38.0	40.0	16	46	270	10
MA411M30	30	41.9	30.0	19	46	222	10
MA411M31	31	43.9	30.0	20.5	46	244	10
MA411M32	32	43.9	30.0	20.5	46	238	10
MA411M33	33	45.9	35.0	22	46	290	10
MA411M34	34	45.9	35.0	22	46	330	10
MA411M35	35	49.9	35.0	22	50	357	10
MA411M36	36	49.9	35.0	22	50	376	10
MA411M37	37	50.9	35.0	25	50	380	10
MA411M38	38	51.9	35.0	25	50	390	10

# 1/2"MA411S Impact Standard Socket

- 1/2" Drive Standard Length
- 6 Points
- Inch Size

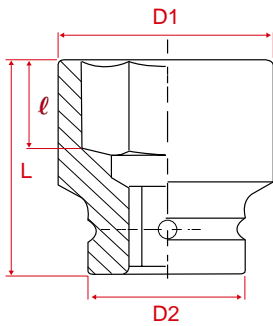

M7 NO.	⊙	D1	D2	ℓ	L	⚖	📦
	inch	mm	mm	mm	mm	g	
MA411S08	1/4"	12.5	24.9	8	38	70	10
MA411S10	5/16"	14.5	24.9	8	38	70	10
MA411S12	3/8"	16.0	24.9	8	38	70	10
MA411S14	7/16"	18.0	24.9	9	38	72	10
MA411S16	1/2"	20.0	24.9	11	38	74	10
MA411S18	9/16"	22.0	24.9	11	38	76	10
MA411S20	5/8"	24.9	24.9	12	38	81	10
MA411S22	11/16"	26.0	25.0	12	38	83	10
MA411S24	3/4"	28.0	25.0	12	38	85	10
MA411S26	13/16"	30.0	25.0	13	38	94	10
MA411S28	7/8"	32.0	30.0	13	38	134	10
MA411S30	15/16"	34.0	30.0	15	38	135	10
MA411S32	1"	36.0	30.0	15	38	144	10
MA411S34	1-1/16"	38.0	30.0	17	40	203	10
MA411S36	1-1/8"	40.0	30.0	18.5	40	260	10
MA411S38	1-3/16"	42.0	30.0	18.5	40	280	10
MA411S40	1-1/4"	44.0	30.0	18.5	40	290	10
MA411S42	1-5/16"	46.0	35.0	21	43	301	10
MA411S44	1-3/8"	48.0	35.0	21	43	338	10
MA411S46	1-7/16"	50.0	44.0	21	43	357	10
MA411S48	1-1/2"	52.0	44.0	23.5	43	376	10

# IMPACT SOCKET

## 1/2"MA431M

### IMPACT DEEP SOCKET

- 1/2" Drive Deep Length
- 6 Points
- Metric Size

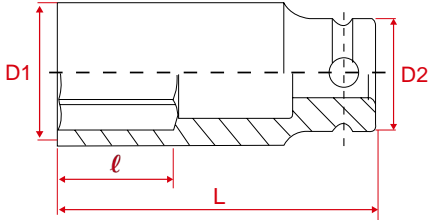

## 1/2"MA431S

### IMPACT DEEP SOCKET

- 1/2" Drive Deep Length
- 6 Points
- Inch Size

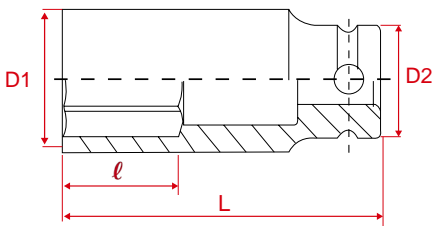

M7 NO.	⊙	D1	D2	ℓ	L	⚖	📦
	mm	mm	mm	mm	mm	g	
MA431M06	6	12.0	24.9	10	82	168	10
MA431M07	7	13.0	24.9	10	82	168	10
MA431M08	8	14.5	24.9	13	82	168	10
MA431M09	9	15.6	24.9	15	82	168	10
MA431M10	10	16.7	24.9	15	82	168	10
MA431M11	11	18.0	24.9	15	82	169	10
MA431M12	12	19.0	24.9	15	82	170	10
MA431M13	13	20.2	24.9	15	82	176	10
MA431M14	14	21.5	24.9	18	82	180	10
MA431M15	15	23.0	25.0	18	82	184	10
MA431M16	16	24.9	25.0	18	82	190	10
MA431M17	17	25.9	25.0	19	82	196	10
MA431M18	18	26.9	25.0	19	82	214	10
MA431M19	19	29.9	30.0	19	82	216	10
MA431M20	20	29.9	30.0	26	82	220	10
MA431M21	21	31.9	30.0	26	82	222	10
MA431M22	22	31.9	30.0	26	82	288	10
MA431M23	23	33.9	30.0	26	82	338	10
MA431M24	24	35.9	30.0	26	82	377	10
MA431M25	25	35.9	30.0	26	82	369	10
MA431M26	26	37.9	30.0	26	82	321	10
MA431M27	27	39.9	30.0	26	82	454	10
MA431M28	28	39.9	30.0	26	82	442	10
MA431M29	29	41.9	30.0	26	82	451	10
MA431M30	30	41.9	30.0	26	82	431	10
MA431M31	31	43.9	35.0	26	90	480	10
MA431M32	32	43.9	35.0	26	90	497	10
MA431M33	33	45.9	35.0	38	90	590	10
MA431M34	34	45.9	35.0	38	90	554	10
MA431M35	35	49.9	40.0	38	93	690	10
MA431M36	36	49.9	40.0	38	93	670	10

M7 NO.	⊙	D1	D2	ℓ	L	⚖	📦
	inch	mm	mm	mm	mm	g	
MA431S08	1/4"	12.5	24.9	10	82	160	10
MA431S10	5/16"	14.5	24.9	13	82	160	10
MA431S12	3/8"	16.0	24.9	15	82	167	10
MA431S14	7/16"	18.0	24.9	15	82	171	10
MA431S16	1/2"	20.0	24.9	15	82	176	10
MA431S18	9/16"	22.0	24.9	17	82	181	10
MA431S20	5/8"	24.9	24.9	18	82	187	10
MA431S22	11/16"	25.9	25.0	18	82	194	10
MA431S24	3/4"	27.9	25.0	18	82	217	10
MA431S26	13/16"	29.9	25.0	26	82	227	10
MA431S28	7/8"	31.9	30.0	26	82	290	10
MA431S30	15/16"	33.9	30.0	26	82	319	10
MA431S32	1"	35.9	30.0	26	82	346	10
MA431S34	1-1/16"	37.9	30.0	26	82	450	10
MA431S36	1-1/8"	39.9	30.0	26	82	450	10
MA431S38	1-3/16"	41.9	30.0	26	82	480	10
MA431S40	1-1/4"	43.9	30.0	26	82	500	10
MA431S42	1-5/16"	45.9	35.0	34	90	565	10
MA431S44	1-3/8"	47.9	35.0	34	90	595	10
MA431S46	1-7/16"	49.9	44.0	34	90	699	10
MA431S48	1-1/2"	51.8	44.0	34	90	744	10



# 3/4"MA611S

## Impact Standard Socket

- 3/4" Drive Standard Length
- 6 Points
- Inch Size

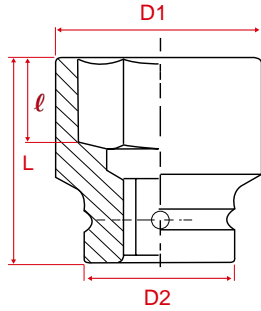

M7 NO.	⊘	D1	D2	ℓ	L	⚖	📦
	inch	mm	mm	mm	mm	g	
MA611S16	1/2"	22	38	6.3	50	380	1
MA611S18	9/16"	25.5	38	6.3	50	380	1
MA611S20	5/8"	27.5	38	7.1	50	380	1
MA611S22	11/16"	29	38	8.1	50	390	1
MA611S24	3/4"	30.2	38	9	52	390	1
MA611S26	13/16"	32	38	10.6	52	400	1
MA611S28	7/8"	34	38	12.2	52	440	1
MA611S30	15/16"	36	38	12.4	52	440	1
MA611S32	1"	38	38	12.4	52	450	1
MA611S34	1-1/16"	40	40	12.4	52	510	1
MA611S36	1-1/8"	42	42	16.1	52	570	1
MA611S38	1-3/16"	44	44	16.1	52	610	1
MA611S40	1-1/4"	46	44	16.1	52	630	1
MA611S42	1-5/16"	50	44	18.8	56	660	1
MA611S44	1-3/8"	52	44	18.8	56	770	1
MA611S46	1-7/16"	54	44	18.8	56	770	1
MA611S48	1-1/2"	56	44	21.5	56	830	1
MA611S50	1-9/16"	58	44	21.5	58	860	1
MA611S52	1-5/8"	60	44	21.5	58	870	1
MA611S54	1-11/16"	63.5	44	24.6	62	1050	1
MA611S56	1-3/4"	65	44	24.9	62	1090	1
MA611S58	1-13/16"	67	44	25.1	63	1150	1
MA611S60	1-7/8"	68	44	27	68	1200	1
MA611S62	1-15/16"	70	44	27	70	1250	1
MA611S64	2"	71	44	27	72	1310	1
MA611S66	2-1/16"	74	54	29.2	72	1380	1
MA611S68	2-1/8"	77	54	30.3	72	1650	1
MA611S70	2-3/16"	77	54	30.3	74	1700	1
MA611S72	2-1/4"	80	54	32.4	74	1720	1
MA611S74	2-5/16"	82	54	32.8	75	1810	1
MA611S76	2-3/8"	84	54	33.1	80	2050	1
MA611S78	2-7/16"	85	54	34.4	80	2080	1
MA611S80	2-1/2"	86	54	34.4	80	2250	1
MA611S82	2-9/16"	88	54	35.1	80	2300	1
MA611S84	2-5/8"	88	54	35.1	80	2300	1
MA611S86	2-11/16"	88	54	36.4	80	2300	1
MA611S88	2-3/4"	96	54	37.8	85	2450	1
MA611S90	2-13/16"	96	60	38.1	88	2550	1
MA611S92	2-7/8"	98	60	39.4	90	2600	1
MA611S94	2-15/16"	100	60	46	92	2700	1
MA611S96	3"	100	60	46	92	2800	1

# 3/4"MA611M

## Impact Standard Socket

- 3/4" Drive Standard Length
- 6 Points
- Metric Size

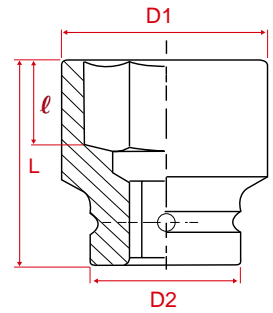

M7 NO.	⊘	D1	D2	ℓ	L	⚖	📦
	mm	mm	mm	mm	mm	g	
MA611M13	13	22	38	7	50	210	1
MA611M14	14	25.5	38	7	50	210	1
MA611M15	15	26	38	7	50	220	1
MA611M16	16	27.5	38	7	50	220	1
MA611M17	17	28.5	38	9.6	50	230	1
MA611M18	18	29.5	38	10.2	52	230	1
MA611M19	19	30	38	11.1	52	230	1
MA611M20	20	31	38	11.5	52	240	1
MA611M21	21	32	38	11.7	52	240	1
MA611M22	22	34	38	12.5	52	250	1
MA611M23	23	35	38	12.7	52	250	1
MA611M24	24	36	38	14	52	250	1
MA611M25	25	38	38	14	52	270	1
MA611M26	26	38	38	14.6	52	270	1
MA611M27	27	40	40	15.8	52	280	1
MA611M28	28	42	42	16.3	52	320	1
MA611M29	29	42	42	16.7	52	320	1
MA611M30	30	46	44	16.7	52	370	1
MA611M31	31	46	44	16.7	52	370	1
MA611M32	32	48	44	18.3	52	380	1
MA611M33	33	50	44	19.1	56	410	1
MA611M34	34	51	44	20	56	410	1
MA611M35	35	52	44	20.1	56	470	1
MA611M36	36	53.5	44	21.5	56	470	1
MA611M37	37	54	44	21.5	56	470	1
MA611M38	38	56	44	22.3	56	470	1
MA611M39	39	56	44	22.3	58	480	1
MA611M40	40	58	44	22.8	58	540	1
MA611M41	41	60	44	23	58	590	1
MA611M42	42	61	44	23	58	660	1
MA611M43	43	63	44	23	62	700	1
MA611M44	44	65	44	23	62	720	1
MA611M45	45	66	44	23	63	740	1
MA611M46	46	67	44	23	63	770	1
MA611M47	47	68	44	27	68	820	1
MA611M48	48	69	44	27	68	830	1
MA611M49	49	70	44	29	70	830	1
MA611M50	50	71	54	29.8	72	970	1
MA611M51	51	71	54	29.8	72	1150	1
MA611M52	52	74	54	29.8	72	1250	1
MA611M54	54	77	54	29.8	72	1250	1
MA611M55	55	77	54	29.8	74	1250	1
MA611M56	56	77	54	31	74	1450	1
MA611M57	57	80	54	31	74	1550	1
MA611M58	58	82	54	31	74	1580	1
MA611M59	59	82	54	33	75	1600	1
MA611M60	60	84	54	33	80	1620	1
MA611M62	62	85	54	33	80	1650	1
MA611M63	63	86	54	33	80	1720	1
MA611M65	65	88	54	33	80	1790	1
MA611M67	67	90	54	35	80	1850	1
MA611M70	70	96	54	35	85	1920	1

# IMPACT SOCKET

## 3/4" MA631S

### Impact Deep Socket

- 3/4" Drive Deep Length
- 6 Points
- Inch Size

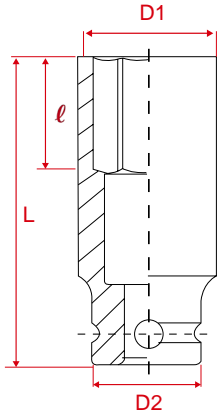

## 3/4" MA631M

### Impact Deep Socket

- 3/4" Drive Deep Length
- 6 Points
- Metric Size

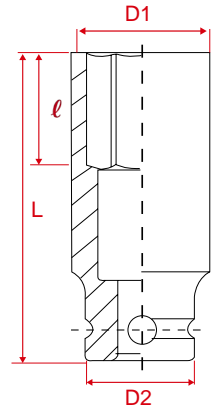

M7 NO.	○	D1	D2	ℓ	L	⚖	📦
	inch	mm	mm	mm	mm	g	
MA631S16	1/2"	22	38	12	90	380	1
MA631S18	9/16"	25.5	38	12	90	380	1
MA631S20	5/8"	27.5	38	12	90	380	1
MA631S22	11/16"	29	38	12	90	380	1
MA631S24	3/4"	30	38	12	90	390	1
MA631S26	13/16"	32	38	12	90	390	1
MA631S28	7/8"	34	38	19	90	400	1
MA631S30	15/16"	36	38	19	90	440	1
MA631S32	1"	38	38	19	90	440	1
MA631S34	1-1/16"	40	40	19	90	450	1
MA631S36	1-1/8"	42	42	19	90	510	1
MA631S38	1-3/16"	44	44	19	90	570	1
MA631S40	1-1/4"	46	44	19	90	610	1
MA631S42	1-5/16"	50	44	19	90	630	1
MA631S44	1-3/8"	52	44	19	90	660	1
MA631S46	1-7/16"	54	44	19	90	770	1
MA631S48	1-1/2"	56	44	22	92	770	1
MA631S50	1-9/16"	58	44	40	92	830	1
MA631S52	1-5/8"	60	44	40	92	860	1
MA631S54	1-11/16"	63.5	44	40	92	870	1
MA631S56	1-3/4"	65	44	40	92	1050	1
MA631S58	1-13/16"	67	44	40	92	1090	1
MA631S60	1-7/8"	68	44	40	92	1150	1
MA631S62	1-15/16"	70	44	40	92	1200	1
MA631S64	2"	71	54	40	95	1250	1
MA631S66	2-1/16"	74	54	40	95	1310	1
MA631S68	2-1/8"	77	54	40	100	1380	1
MA631S70	2-3/16"	77	54	40	100	1650	1
MA631S72	2-1/4"	80	54	40	100	1700	1
MA631S74	2-5/16"	82	54	40	105	1720	1
MA631S76	2-3/8"	84	54	40	105	1810	1
MA631S78	2-7/16"	85	54	40	105	2050	1
MA631S80	2-1/2"	86	54	40	105	2080	1
MA631S82	2-9/16"	88	54	40	105	2250	1
MA631S84	2-5/8"	90	54	40	105	2300	1
MA631S86	2-11/16"	92	54	40	105	2350	1
MA631S88	2-3/4"	96	54	40	105	2400	1
MA631S90	2-13/16"	98	54	40	105	2450	1
MA631S92	2-7/8"	100	54	40	105	2650	1
MA631S94	2-15/16"	102	54	40	105	2850	1
MA631S96	3"	104	54	40	105	3050	1

M7 NO.	○	D1	D2	ℓ	L	⚖	📦
	mm	mm	mm	mm	mm	g	
MA631M13	13	22	38	12	90	380	1
MA631M14	14	25.5	38	12	90	380	1
MA631M15	15	26	38	12	90	380	1
MA631M16	16	27.5	38	12	90	380	1
MA631M17	17	28.5	38	12	90	390	1
MA631M18	18	29.5	38	12	90	390	1
MA631M19	19	30	38	12	90	390	1
MA631M20	20	31	38	19	90	390	1
MA631M21	21	32	38	19	90	400	1
MA631M22	22	34	38	19	90	430	1
MA631M23	23	35	38	19	90	430	1
MA631M24	24	36	38	19	90	440	1
MA631M25	25	38	38	19	90	460	1
MA631M26	26	40	40	19	90	460	1
MA631M27	27	40	40	19	90	500	1
MA631M28	28	42	42	19	90	550	1
MA631M29	29	42	42	19	90	560	1
MA631M30	30	46	44	19	92	620	1
MA631M31	31	47	44	19	92	620	1
MA631M32	32	48	44	19	92	630	1
MA631M33	33	50	44	19	92	670	1
MA631M34	34	51	44	19	92	670	1
MA631M35	35	52	44	19	92	770	1
MA631M36	36	53.5	44	19	92	790	1
MA631M37	37	54	44	19	92	800	1
MA631M38	38	56	44	19	95	830	1
MA631M39	39	56	44	40	95	850	1
MA631M40	40	58	44	40	100	880	1
MA631M41	41	60	44	40	100	880	1
MA631M42	42	61	44	40	100	1050	1
MA631M43	43	63	44	40	105	1050	1
MA631M44	44	64	44	40	105	1060	1
MA631M45	45	66	44	40	105	1100	1
MA631M46	46	67	44	40	105	1150	1
MA631M47	47	68	44	40	105	1160	1
MA631M48	48	69	44	40	105	1200	1
MA631M49	49	70	44	40	105	1240	1
MA631M50	50	71	54	40	105	1320	1
MA631M51	51	72	54	40	105	1420	1
MA631M52	52	54	74	40	105	1530	1
MA631M54	54	76	54	40	105	1650	1
MA631M55	55	77	54	40	105	1670	1
MA631M56	56	78	54	40	105	1720	1
MA631M57	57	80	54	40	105	1820	1
MA631M58	58	82	54	40	105	1920	1
MA631M59	59	82	54	40	105	1920	1
MA631M60	60	84	54	40	105	2020	1
MA631M62	62	85	54	40	105	2080	1
MA631M65	65	88	54	40	105	2300	1
MA631M67	67	92	54	40	105	2350	1
MA631M70	70	96	54	40	105	2450	1

# 1" MA811S Impact Standard Socket

- 1" Drive Standard Length
- 6 Points
- Inch Size

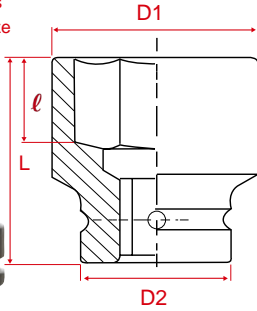

# 1" MA811M Impact Standard Socket

- 1" Drive Standard Length
- 6 Points
- Metric Size

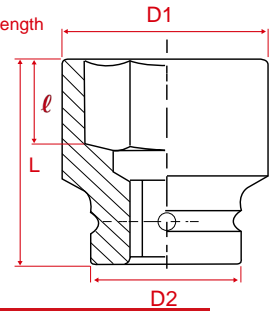

M7 NO.	⊘	D1	D2	l	L	⚖	📦
	inch	mm	mm	mm	mm	g	
MA811S20	5/8"	32	51	8	58	470	1
MA811S22	11/16"	34	51	8.1	58	480	1
MA811S24	3/4"	36	51	9.5	58	500	1
MA811S26	13/16"	38	51	11	58	510	1
MA811S28	7/8"	39	51	12.5	58	510	1
MA811S30	15/16"	40	51	12.5	58	510	1
MA811S32	1"	42	51	12.5	58	520	1
MA811S34	1-1/16"	44	51	12.5	58	520	1
MA811S36	1-1/8"	46	51	12.5	58	530	1
MA811S38	1-3/16"	48	51	16.5	60	550	1
MA811S40	1-1/4"	51	51	16.5	60	610	1
MA811S42	1-5/16"	52	52	19	62	620	1
MA811S44	1-3/8"	54	54	19	62	630	1
MA811S46	1-7/16"	56	54	19	62	640	1
MA811S48	1-1/2"	58	54	22	62	670	1
MA811S50	1-9/16"	60	54	22	62	870	1
MA811S52	1-5/8"	61.5	54	22	62	920	1
MA811S54	1-11/16"	65	54	25	64	920	1
MA811S56	1-3/4"	66	58	25	64	1000	1
MA811S58	1-13/16"	68	58	25.6	64	1000	1
MA811S60	1-7/8"	70	58	27	66	1080	1
MA811S62	1-15/16"	72	58	27	68	1080	1
MA811S64	2"	74	58	27	70	1100	1
MA811S66	2-1/16"	75	58	30	70	1200	1
MA811S68	2-1/8"	78	58	30	70	1250	1
MA811S70	2-3/16"	80	62	30	72	1450	1
MA811S72	2-1/4"	84	62	32.5	75	1520	1
MA811S74	2-5/16"	86	62	32.5	75	1520	1
MA811S76	2-3/8"	87	62	33.5	78	1720	1
MA811S78	2-7/16"	89	62	34	78	1890	1
MA811S80	2-1/2"	91	62	34	80	1900	1
MA811S82	2-9/16"	93	62	35	80	1900	1
MA811S84	2-5/8"	95	62	37.5	82	2000	1
MA811S86	2-11/16"	97	62	37.5	82	2200	1
MA811S88	2-3/4"	98	62	38	85	2250	1
MA811S90	2-13/16"	100	62	40	87	2380	1
MA811S92	2-7/8"	102	62	40	87	2400	1
MA811S94	2-15/16"	104	86	41	95	3190	1
MA811S96	3"	106	86	43	98	3450	1
MA811S98	3-1/16"	107	86	43.5	100	3550	1
MA811S100	3-1/8"	109	86	43.5	100	3620	1
MA811S104	3-1/4"	113	86	43.5	100	3800	1
MA811S108	3-3/8"	115	86	47.5	100	4050	1
MA811S112	3-1/2"	125	86	49	105	5170	1
MA811S116	3-5/8"	127	86	51	105	5200	1
MA811S120	3-3/4"	130	86	51	105	5250	1
MA811S124	3-7/8"	136	95	55	105	5990	1
MA811S126	3-15/16"	137	95	55	105	6000	1
MA811S128	4"	140	95	56	105	6000	1
MA811S132	4-1/8"	143	95	57.5	105	6500	1
MA811S136	4-1/4"	147	95	58.5	105	7200	1
MA811S144	4-1/2"	152	95	61	105	10000	1

M7 NO.	⊘	D1	D2	l	L	⚖	📦
	mm	mm	mm	mm	mm	g	
MA811M17	17	34	51	11.5	58	490	1
MA811M18	18	35	51	11.5	58	500	1
MA811M19	19	35	51	11.5	58	500	1
MA811M20	20	37	51	11.5	58	500	1
MA811M21	21	38	51	11.5	58	500	1
MA811M22	22	39	51	12.5	58	510	1
MA811M23	23	40	51	13	58	510	1
MA811M24	24	40.5	51	14	58	510	1
MA811M25	25	41	51	14.5	58	510	1
MA811M26	26	42.5	51	15	58	520	1
MA811M27	27	44	51	16	58	520	1
MA811M28	28	45	51	16	58	530	1
MA811M29	29	46	51	16.5	60	530	1
MA811M30	30	48	51	17	60	530	1
MA811M32	32	51	51	18.5	62	590	1
MA811M33	33	52	52	19.5	62	620	1
MA811M34	34	54	54	19.5	62	640	1
MA811M35	35	54	54	20.5	62	650	1
MA811M36	36	56	54	21.5	62	670	1
MA811M37	37	57	54	22	62	670	1
MA811M38	38	58	54	22.5	62	680	1
MA811M39	39	58.7	54	23	62	770	1
MA811M40	40	60	54	23	62	870	1
MA811M41	41	61.5	54	23	62	920	1
MA811M42	42	63	54	23	64	980	1
MA811M43	43	65	54	23	64	1000	1
MA811M44	44	65	54	23	64	1000	1
MA811M45	45	66	54	23	64	1000	1
MA811M46	46	68	54	23	64	1000	1
MA811M47	47	69	54	24	66	1000	1
MA811M48	48	70	54	27	66	1050	1
MA811M49	49	70	54	27	66	1050	1
MA811M50	50	73	54	27	70	1070	1
MA811M51	51	73	54	27	70	1070	1
MA811M52	52	75	54	27	70	1200	1
MA811M53	53	75	54	27	70	1200	1
MA811M54	54	75	54	28	70	1200	1
MA811M55	55	79	54	28	72	1440	1
MA811M56	56	80	54	32	72	1350	1
MA811M57	57	80	54	32	72	1350	1
MA811M58	58	85	54	32	75	1620	1
MA811M59	59	85	54	36	75	1620	1
MA811M60	60	87	54	36	78	1730	1
MA811M61	61	87	54	36	78	1730	1
MA811M62	62	91	54	36	80	1900	1
MA811M65	65	93	54	36	80	1900	1
MA811M70	70	104	86	40	85	2190	1
MA811M73	73	104	86	40	90	2800	1
MA811M75	75	104	86	40	95	3200	1
MA811M76	76	106	86	43	98	3480	1
MA811M80	80	109	86	47	100	3650	1
MA811M85	85	115	86	47	100	4100	1
MA811M90	90	125	86	47	105	5200	1
MA811M95	95	130	86	50	105	5250	1
MA811M100	100	137	95	55	105	6050	1
MA811M105	105	143	95	55	105	6550	1
MA811M110	110	147	95	55	105	7250	1
MA811M115	115	152	95	55	105	10000	1
MA811M120	120	160	95	60	110	14000	1
MA811M125	125	165	95	63	115	19000	1

IMPACT SOCKET

# IMPACT SOCKET

## 1"MA831S

### Impact Deep Socket

- 1" Drive Deep Length
- 6 Points
- Inch Size

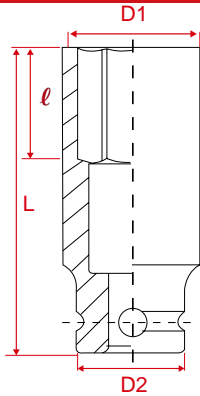

M7 NO.	○	D1	D2	l	L	⚖	📦
	inch	mm	mm	mm	mm	g	
MA831S20	5/8"	32	51	9	90	600	1
MA831S22	11/16"	34	51	16	90	620	1
MA831S24	3/4"	36	51	16	90	700	1
MA831S26	13/16"	38	51	16	90	700	1
MA831S28	7/8"	39	51	16	90	710	1
MA831S30	15/16"	40	51	16	90	720	1
MA831S32	1"	42	51	19	90	760	1
MA831S34	1-1/16"	44	51	19	90	800	1
MA831S36	1-1/8"	46	51	19	90	800	1
MA831S38	1-3/16"	48	51	19	90	820	1
MA831S40	1-1/4"	51	51	19	90	910	1
MA831S42	1-5/16"	52	52	23	90	910	1
MA831S44	1-3/8"	54	54	23	90	910	1
MA831S46	1-7/16"	56	54	23	90	950	1
MA831S48	1-1/2"	58	54	23	92	1000	1
MA831S50	1-9/16"	60	54	40	92	1200	1
MA831S52	1-5/8"	61.5	54	40	92	1200	1
MA831S54	1-11/16"	65	54	40	92	1200	1
MA831S56	1-3/4"	66	58	40	92	1350	1
MA831S58	1-13/16"	68	58	40	92	1350	1
MA831S60	1-7/8"	70	58	40	92	1500	1
MA831S62	1-15/16"	72	58	40	92	1560	1
MA831S64	2"	74	58	40	95	1560	1
MA831S66	2-1/16"	75	58	52	95	1600	1
MA831S68	2-1/8"	78	58	52	100	1750	1
MA831S70	2-3/16"	80	62	52	100	2000	1
MA831S72	2-1/4"	84	62	52	100	2200	1
MA831S74	2-5/16"	86	62	52	105	2260	1
MA831S76	2-3/8"	87	62	52	105	2350	1
MA831S78	2-7/16"	89	62	60	110	2500	1
MA831S80	2-1/2"	91	62	60	110	2580	1
MA831S82	2-9/16"	93	62	60	120	3000	1
MA831S84	2-5/8"	95	62	60	120	3220	1
MA831S86	2-11/16"	97	62	60	124	3250	1
MA831S88	2-3/4"	98	62	60	124	3280	1
MA831S90	2-13/16"	100	62	60	128	3700	1
MA831S92	2-7/8"	102	62	60	128	4150	1
MA831S94	2-15/16"	104	86	60	135	4550	1
MA831S96	3"	106	86	60	135	4550	1
MA831S98	3-1/16"	107	86	60	135	4850	1
MA831S100	3-1/8"	109	86	75	135	4850	1
MA831S104	3-1/4"	113	86	75	135	5150	1
MA831S108	3-3/8"	115	86	75	140	5250	1
MA831S112	3-1/2"	125	86	75	140	5750	1
MA831S116	3-5/8"	127	86	75	140	6050	1
MA831S120	3-3/4"	130	86	75	140	6320	1
MA831S124	3-7/8"	136	95	75	140	7400	1
MA831S126	3-15/16"	137	95	75	140	7500	1
MA831S128	4"	140	95	75	155	7500	1
MA831S132	4-1/8"	143	95	75	155	9800	1
MA831S136	4-1/4"	147	95	75	155	10000	1
MA831S144	4-1/2"	152	95	75	155	10000	1

## 1"MA831M

### Impact Deep Socket

- 1" Drive Deep Length
- 6 Points
- Metric Size

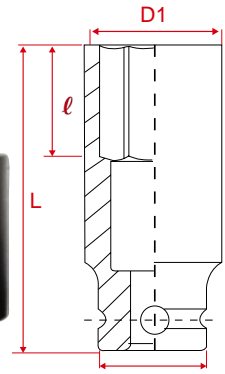

M7 NO.	○	D1	D2	l	L	⚖	📦
	mm	mm	mm	mm	mm	g	
MA831M17	17	34	51	16	90	620	1
MA831M18	18	35	51	16	90	630	1
MA831M19	19	36	51	16	90	700	1
MA831M20	20	37	51	16	90	700	1
MA831M21	21	38	51	16	90	710	1
MA831M22	22	39	51	16	90	710	1
MA831M23	23	40	51	16	90	710	1
MA831M24	24	40.5	51	16	90	720	1
MA831M25	25	41	51	19	90	720	1
MA831M26	26	42.5	51	19	90	750	1
MA831M27	27	44	51	19	90	800	1
MA831M28	28	45	51	19	90	800	1
MA831M29	29	46	51	19	90	800	1
MA831M30	30	48	51	19	90	800	1
MA831M32	32	51	51	19	90	910	1
MA831M33	33	52	52	30	90	910	1
MA831M34	34	54	54	30	90	950	1
MA831M35	35	54	54	30	90	950	1
MA831M36	36	56	54	30	90	950	1
MA831M37	37	57	54	30	90	960	1
MA831M38	38	58	54	30	92	990	1
MA831M39	39	58.7	54	40	92	1060	1
MA831M40	40	60	54	40	92	1200	1
MA831M41	41	61.5	54	40	92	1200	1
MA831M42	42	63	54	40	92	1200	1
MA831M43	43	65	54	40	92	1200	1
MA831M44	44	65	54	40	92	1380	1
MA831M45	45	66	54	40	92	1390	1
MA831M46	46	68	54	40	92	1400	1
MA831M47	47	69	54	40	92	1410	1
MA831M48	48	70	54	40	92	1450	1
MA831M49	49	72	58	40	92	1430	1
MA831M50	50	73	54	40	95	1570	1
MA831M51	51	74	58	40	95	1570	1
MA831M52	52	75	58	52	95	1600	1
MA831M54	54	78	58	52	100	1750	1
MA831M55	55	79	54	52	100	1950	1
MA831M56	56	80	62	52	100	2150	1
MA831M57	57	84	62	52	100	2200	1
MA831M58	58	85	54	52	100	2100	1
MA831M59	59	86	62	52	105	2350	1
MA831M60	60	87	54	52	105	2350	1
MA831M62	62	89	62	60	110	2450	1
MA831M63	63	91	54	60	110	2550	1
MA831M65	65	93	54	60	120	2950	1
MA831M70	70	98	54	60	124	3300	1
MA831M73	73	102	62	60	128	4150	1
MA831M75	75	104	86	60	135	4650	1
MA831M76	76	106	86	60	135	4950	1
MA831M78	78	107	86	60	135	5450	1
MA831M80	80	109	86	75	135	6000	1
MA831M85	85	115	86	75	140	7500	1
MA831M90	90	125	86	75	140	9000	1
MA831M95	95	130	86	75	140	10500	1
MA831M100	100	137	95	75	140	12000	1
MA831M105	105	143	95	75	155	13500	1
MA831M110	110	147	95	75	155	15000	1
MA831M115	115	152	95	75	155	16500	1



# 1-1/2"MA911S

Impact Standard Socket

- 1-1/2" Drive Standard Length
- 6 Points
- Inch Size

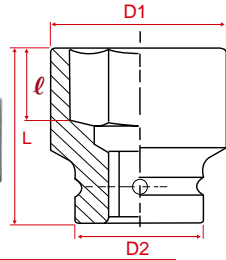

M7 NO.	⊘	D1	D2	l	L	⚖	📦
MA911S38	1-3/16"	56	86	16.5	78	2200	1
MA911S40	1-1/4"	58	86	16.5	78	2200	1
MA911S42	1-5/16"	60	86	19	78	2200	1
MA911S44	1-3/8"	62	86	19.5	78	2200	1
MA911S46	1-4/16"	64	86	22.5	78	2000	1
MA911S48	1-1/2"	66	86	24	78	2200	1
MA911S50	1-9/16"	68	86	25.5	78	2200	1
MA911S52	1-5/8"	70	86	27	80	2200	1
MA911S54	1-11/16"	71	86	27	80	2200	1
MA911S56	1-3/4"	75	86	28.5	84	2300	1
MA911S58	1-13/16"	76	86	29	84	2300	1
MA911S60	1-7/8"	78	86	30	84	2300	1
MA911S62	1-15/16"	80	86	31	87	2400	1
MA911S64	2"	82	86	32	87	2400	1
MA911S66	2-1/16"	83	86	33	87	2400	1
MA911S68	2-1/8"	86	86	34.5	90	2500	1
MA911S70	2-3/16"	86	86	35	90	2500	1
MA911S72	2-1/4"	86	86	36	92	2800	1
MA911S74	2-5/16"	92	86	37	92	3100	1
MA911S76	2-3/8"	93	86	38.5	92	3100	1
MA911S78	2-7/16"	96	86	39.5	95	3400	1
MA911S80	2-1/2"	97	86	40.5	95	3400	1
MA911S82	2-9/16"	97	86	41	95	3400	1
MA911S84	2-5/8"	103	86	42.5	100	3600	1
MA911S86	2-11/16"	104	86	43	100	3800	1
MA911S88	2-3/4"	105	86	44.5	100	3800	1
MA911S90	2-13/16"	108	86	45.3	103	4000	1
MA911S92	2-7/8"	108	86	46.5	103	4100	1
MA911S94	2-15/16"	110	86	47	103	4200	1
MA911S96	3"	110	86	48	103	4300	1
MA911S98	3-1/16"	115	86	49.5	110	4400	1
MA911S100	3-1/8"	116	86	51	110	4500	1
MA911S102	3-3/16"	125	86	51	110	4800	1
MA911S104	3-1/4"	125	86	52	110	5500	1
MA911S106	3-5/16"	125	86	53.5	118	5500	1
MA911S108	3-3/8"	125	86	54	118	5500	1
MA911S110	3-7/16"	128	86	55	118	5700	1
MA911S112	3-1/2"	130	86	57.5	118	5800	1
MA911S114	3-9/16"	132	86	57.5	118	6000	1
MA911S116	3-5/8"	134	86	58	118	6200	1
MA911S118	3-11/16"	136	86	59.5	118	6400	1
MA911S120	3-3/4"	137	95	60.5	118	6600	1
MA911S122	3-13/16"	140	95	61.5	125	8600	1
MA911S124	3-7/8"	142	95	63.5	125	8900	1
MA911S126	3-15/16"	144	95	63.5	125	9300	1
MA911S128	4"	145	95	63.5	125	9450	1
MA911S130	4-1/16"	146	95	66	125	9450	1
MA911S132	4-1/8"	150	95	66	125	9500	1
MA911S134	4-3/16"	151	95	67	125	9500	1
MA911S136	4-1/4"	153	95	70	125	10300	1
MA911S138	4-5/16"	156	95	70	125	10700	1
MA911S140	4-3/8"	160	95	70	125	11500	1
MA911S142	4-7/16"	162	95	71.5	125	11800	1
MA911S144	4-1/2"	163	95	72	135	12000	1
MA911S146	4-5/8"	165	95	76.5	135	12600	1
MA911S148	4-3/4"	168	95	76.5	135	13500	1
MA911S150	5"	179	127	77	140	14500	1

# 1-1/2"MA911M

Impact Standard Socket

- 1-1/2" Drive Standard Length
- 6 Points
- Metric Size

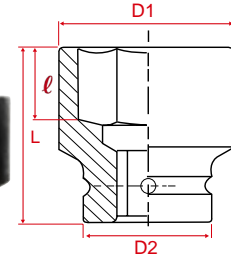

M7 NO.	⊘	D1	D2	l	L	⚖	📦
MA911M30	30	56	86	17	78	2200	1
MA911M32	32	58	86	19	78	2200	1
MA911M34	34	61	86	20	78	2200	1
MA911M35	35	61	86	20	78	2200	1
MA911M36	36	64	86	22	78	2200	1
MA911M38	38	66	86	23	78	2200	1
MA911M40	40	68	86	23	78	2200	1
MA911M41	41	70	86	25	80	2200	1
MA911M42	42	70	86	25	80	2200	1
MA911M46	46	76	86	29	84	2200	1
MA911M50	50	81	86	30	87	2400	1
MA911M51	51	81	86	30	87	2400	1
MA911M52	52	87	86	30	88	2400	1
MA911M53	53	87	86	30	88	2400	1
MA911M54	54	87	86	30	88	2400	1
MA911M55	55	87	86	34	90	2500	1
MA911M57	57	87	86	34	90	2500	1
MA911M58	58	87	86	34	90	2500	1
MA911M60	60	93	86	35	92	3100	1
MA911M62	62	93	86	35	92	3100	1
MA911M63	63	93	86	35	92	3100	1
MA911M65	65	97	86	35	95	3400	1
MA911M66	66	97	86	35	95	3400	1
MA911M67	67	97	86	35	95	3400	1
MA911M68	68	104	86	35	100	3800	1
MA911M70	70	105	86	35	100	3,800	1
MA911M72	72	105	86	35	100	3800	1
MA911M73	73	108	86	35	103	4100	1
MA911M75	75	110	86	35	103	4200	1
MA911M76	76	110	86	35	103	4300	1
MA911M78	78	115	86	38	110	4400	1
MA911M80	80	116	86	38	110	4650	1
MA911M85	85	125	86	41	118	5500	1
MA911M90	90	130	86	44	118	5800	1
MA911M95	95	137	95	46	118	6600	1
MA911M100	100	144	95	48	125	9300	1
MA911M105	105	150	95	51	125	9500	1
MA911M110	110	156	95	54	125	10500	1
MA911M115	115	160	95	56	135	12100	1
MA911M120	120	168	95	58	135	13200	1
MA911M125	125	175	95	61	135	14000	1
MA911M130	130	180	127	64	145	18000	1
MA911M135	135	186	127	68	150	19000	1
MA911M140	140	192	127	70	150	20000	1
MA911M145	145	198	127	74	150	21000	1
MA911M150	150	203	127	78	150	22000	1
MA911M155	155	209	127	78	150	24500	1
MA911M160	160	222	127	82	175	29800	1
MA911M165	165	228	127	90	175	32000	1
MA911M175	175	235	127	94	175	34500	1

IMPACT SOCKET

# IMPACT SOCKET

## 1-1/2" MA931M

### Impact Deep Socket

- 1-1/2" Drive Deep Length
- 6 Points
- Metric Size

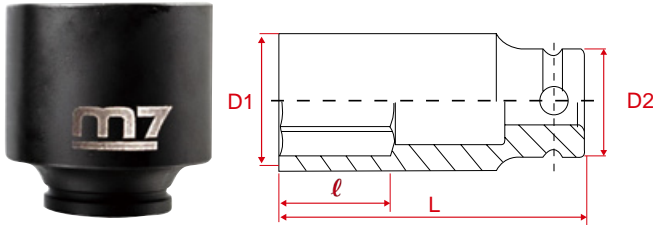

## 1-1/2" MA931S

### Impact Deep Socket

- 1-1/2" Drive Deep Length
- 6 Points
- Inch Size

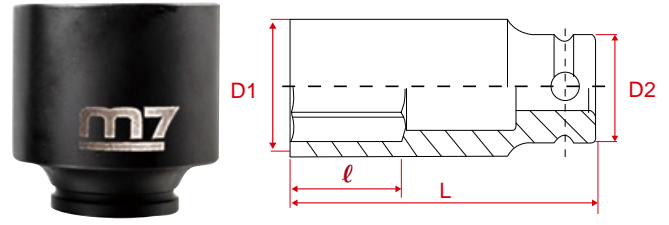

M7 NO.	○	D1	D2	l	L	⚖	📦
	inch	mm	mm	mm	mm	g	
MA931M41	41	70	86	25	115	3200	1
MA931M42	42	73	86	27	115	3200	1
MA931M46	46	76	86	29	115	3200	1
MA931M49	49	80	86	30	115	3200	1
MA931M50	50	81	86	30	135	3200	1
MA931M54	54	86	86	34	140	3900	1
MA931M55	55	87	86	34	140	3900	1
MA931M57	57	86	86	35	150	4300	1
MA931M58	58	93	86	35	150	4600	1
MA931M60	60	96	86	35	150	5150	1
MA931M62	62	97	86	35	150	5150	1
MA931M65	65	105	86	35	150	5700	1
MA931M70	70	108	86	35	160	6700	1
MA931M73	73	110	86	35	170	7800	1
MA931M75	75	110	86	35	170	7800	1
MA931M76	76	115	86	35	170	8200	1
MA931M78	78	116	86	38	170	8200	1
MA931M80	80	125	86	41	170	8600	1
MA931M85	85	130	86	44	170	9900	1
MA931M95	95	137	95	46	180	12200	1
MA931M100	100	144	95	48	190	14100	1

M7 NO.	○	D1	D2	l	L	⚖	📦
	inch	mm	mm	mm	mm	g	
MA931S48	1-1/2"	68	86	27	115	3200	1
MA931S52	1-5/8"	70	86	27	115	3200	1
MA931S54	1-11/16"	73	86	27	115	3200	1
MA931S56	1-3/4"	75	86	28.5	115	3200	1
MA931S58	1-13/16"	76	86	29	115	3200	1
MA931S60	1-7/8"	78	86	30	115	3200	1
MA931S62	1-15/16"	80	86	31	115	3600	1
MA931S64	2"	82	86	32	135	3800	1
MA931S66	2-1/16"	83	86	33	140	3900	1
MA931S68	2-1/8"	86	86	35	140	3900	1
MA931S70	2-3/16"	86	86	35	140	3900	1
MA931S72	2-1/4"	86	86	36	150	4700	1
MA931S74	2-5/16"	92	86	37	150	4700	1
MA931S76	2-3/8"	93	86	38.5	150	5200	1
MA931S78	2-7/16"	96	86	39.5	150	5200	1
MA931S80	2-1/2"	97	86	40.5	150	5200	1
MA931S82	2-9/16"	97	86	41	150	5700	1
MA931S84	2-5/8"	103	86	42.5	150	5700	1
MA931S86	2-11/16"	104	86	43	150	6300	1
MA931S88	2-3/4"	105	86	45	160	6700	1
MA931S90	2-13/16"	108	86	45.5	160	6700	1
MA931S92	2-7/8"	108	86	46.5	160	73200	1
MA931S94	2-15/16"	110	86	47	170	7800	1
MA931S96	3"	110	86	48	170	8500	1
MA931S98	3-1/16"	115	86	49.5	170	8500	1
MA931S100	3-1/8"	116	86	51	170	8500	1
MA931S102	3-3/16"	125	86	51	170	9900	1
MA931S104	3-1/4"	125	86	52	170	9900	1
MA931S106	3-5/16"	125	86	53.5	170	9900	1
MA931S108	3-3/8"	125	86	54	170	9900	1
MA931S110	3-7/16"	128	86	55	170	10300	1
MA931S112	3-1/2"	130	86	57.5	170	10700	1
MA931S114	3-9/16"	132	86	57.5	170	10700	1
MA931S116	3-5/8"	134	86	58	170	11000	1
MA931S118	3-11/16"	136	86	59.5	170	11200	1
MA931S120	3-3/4"	137	95	60.5	180	12200	1
MA931S122	3-13/16"	140	95	61.5	180	12500	1
MA931S124	3-7/8"	142	95	63.5	180	13100	1
MA931S126	3-15/16"	144	95	63.5	190	14100	1
MA931S128	4"	145	95	63.5	190	14900	1
MA931S130	4-1/16"	146	95	66	190	15200	1
MA931S140	4-3/8"	160	95	70	200	18200	1
MA931S142	4-7/16"	162	95	71.5	200	19100	1
MA931S144	4-1/2"	163	95	72	210	20100	1
MA931S148	4-5/8"	165	95	76.5	210	20900	1
MA931S152	4-3/4"	168	95	76.5	210	21500	1

IMPACT SOCKET

### 3/4" MA641M

4 POINT SQUARE IMPACT SOCKET

- 3/4" Drive Deep Length
- 4 Points
- Metric Size



M7 NO.	○	D1	D2	L	⚖
	inch	mm	mm	mm	mm
MA641M17	17	37	44	52	320
MA641M19	19	39	44	52	320
MA641M20	20	41	44	52	350
MA641M21	21	42	44	52	350

### 3/4" MA641S

4 POINT SQUARE IMPACT SOCKET

- 3/4" Drive Deep Length
- 4 Points
- Inch Size



M7 NO.	○	D1	D2	L	⚖
	inch	mm	mm	mm	mm
MA641S24	3/4"	37	44	52	320
MA641S26	13/16"	39	44	52	320

### 3/4" MA643M

4 POINT SQUARE IMPACT SOCKET

- 3/4" Drive Deep Length
- 4 Points
- Metric Size



M7 NO.	○	D1	D2	L	⚖
	inch	mm	mm	mm	mm
MA643M17	17	37	44	90	600
MA643M19	19	39	44	90	620
MA643M20	20	41	44	90	660
MA643M21	21	42	44	90	670
MA643M22	22	42	44	90	670

### 1" MA841M

4 POINT SQUARE IMPACT SOCKET

- 1" Drive Deep Length
- 4 Points
- Metric Size



M7 NO.	○	D1	D2	L	⚖
	inch	mm	mm	mm	mm
MA841M17	17	40	54	57	360
MA841M19	19	43	54	57	360
MA841M20	20	45	54	57	390
MA841M21	21	47	54	57	390
MA841M22	22	47	54	57	390

### 1" MA841S

4 POINT SQUARE IMPACT SOCKET

- 1" Drive Deep Length
- 4 Points
- Inch Size



M7 NO.	○	D1	D2	L	⚖
	inch	mm	mm	mm	mm
MA841S24	3/4"	43	54	57	380
MA841S26	13/16"	47	54	57	390
MA841S30	15/16"	48	54	57	430

### 1" MA843M

4 POINT SQUARE IMPACT SOCKET

- 1" Drive Deep Length
- 4 Points
- Metric Size



M7 NO.	○	D1	D2	L	⚖
	inch	mm	mm	mm	mm
MA843M17	17	40	54	76	680
MA843M19	19	43	54	76	700
MA843M20	20	45	54	76	720
MA843M21	21	47	54	76	740
MA843M22	22	47	54	76	740

# IMPACT SOCKET

## NEW PRODUCT

### 1/2"ME471T

#### Star Bit Socket

- 1/2" Drive Deep Length
- 6 Points
- Inch Size



M7 NO.		D1	D2	L		
	T	mm	mm	mm	g	
ME471T10	T10	6	24.7	78	71	1
ME471T15	T15	6	24.7	78	71	1
ME471T20	T20	6	24.7	78	68	1
ME471T25	T25	6	24.7	78	74	1
ME471T27	T27	6	24.7	78	76	1
ME471T30	T30	6.5	24.7	78	76	1
ME471T40	T40	7.5	24.7	78	81	1
ME471T45	T45	8.5	24.7	78	85	1
ME471T47	T47	8.5	24.7	78	85	1
ME471T50	T50	9.5	24.7	78	87	1
ME471T55	T55	12	24.7	78	106	1
ME471T60	T60	14	24.7	78	118	1
ME471T70	T70	16	24.7	78	135	1
ME471T80	T80	18	24.7	78	155	1

### ME271M08-7

#### Extension Bit Socket

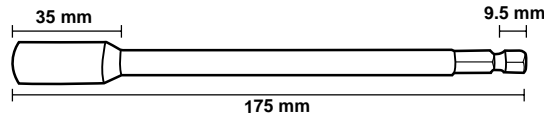

### ME271M10-7

#### Extension Bit Socket

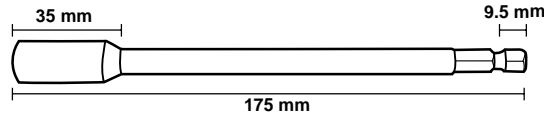

## SOCKET STICKERS PACK



M7 NO.	Drive
8702	1/4"
8703	3/8"
8704	1/2"
8706	3/4"
8708	1"

M7 NO.	Drive
8702-1	1/4"
8703-1	3/8"
8704-1	1/2"
8706-1	3/4"
8708-1	1"

## Male Adapter



M7 NO.	Spec	D	L		
	inch	mm	mm	g	
ME382	3/8" F x 1/4" M	22	32	12	10
ME384	3/8" F x 1/2" M	22	32	50	10
ME483	1/2" F x 3/8" M	25	38	65	10
ME486	1/2" F x 3/4" M	30	48	161	10
ME486H	1/2" F x 3/4" M	30	48	161	10
ME688	3/4" F x 1" M	46	68	437	10
ME688H	3/4" F x 1" M	46	46	437	10
ME684	3/4" F x 1/2" M	44	60	343	10
ME684H	3/4" F x 1/2" M	44	60	343	10
ME886	1" F x 3/4" M	56	80	653	10
ME886H	1" F x 3/4" M	56	80	653	10
ME889	1" F x 1-1/2" M	54	90	1078	10



## Universal Joint

M7 NO.	Size	D	Total Length			
	inch	mm	inch	mm	g	
ME2711	1/4"	20	1-3/4"	65	42	10
ME3711	3/8"	27	2"	51	102	10
ME4711	1/2"	34	2-7/16"	61	208	10
ME6711	3/4"	49	3-1/2"	90.4	641	10
ME6711H	3/4"	49	3-1/2"	90.4	641	10
ME8711	1"	59	4-1/2"	114	1199	10
ME8711H	1"	59	4-1/2"	114	1199	10
ME9711	1-1/2"	90	6-11/16"	170	1312	10



## 1/4"ME221 1/4" Drive Extension Bar



M7 NO.	Total Length		g	10
	inch	mm		
ME221-02	2"	50	26	10
ME221-04	4"	100	46	10
ME221-06	6"	150	67	10

## 3/8"ME321 3/8" Drive Extension Bar



M7 NO.	Total Length		g	10
	inch	mm		
ME321-03	3"	75	79	10
ME321-05	5"	125	124	10
ME321-06	6"	150	140	10
ME321-10	10"	250	242	10
ME321-12	12"	300	288	10
ME321-15	15"	375	354	10

## 1/2"ME421 1/2" Drive Extension Bar



Without Ball : ME421-05H, MEN421-10H

M7 NO.	Total Length		g	10
	inch	mm		
ME421-03	3"	75	142	10
ME421-05	5"	125	228	10
ME421-05H	5"	125	228	10
ME421-10	10"	250	653	10
ME421-10H	10"	250	653	10
ME421-15	15"	375	1041	10

## 1/2"ME471S

Impact Hex Bit  
1/2" Drive Inch Size SAE

M7 NO.	inch	Total Length		g	10
		mm	g		
ME471S06	3/16"	78	90	10	
ME471S07	7/32"	78	90	10	
ME471S08	1/4"	78	69	10	
ME471S09	9/32"	78	95	10	
ME471S10	5/16"	78	94	10	
ME471S11	11/32"	78	105	10	
ME471S12	3/8"	78	105	10	
ME471S14	7/16"	78	119	10	
ME471S16	1/2"	78	134	10	
ME471S18	9/16"	78	151	10	
ME471S20	5/8"	78	173	10	
ME471S22	11/16"	78	194	10	
ME471S24	3/4"	78	215	10	
ME471S26	13/16"	78	229	10	



## 3/4" ME621 3/4" Drive Extension Bar



Without Ball :  
ME621-04H, ME621-06H, ME621-07H, ME621-10H, ME621-13H

M7 NO.	Total Length		g	10
	inch	mm		
ME621-04	4"	100	609	10
ME621-04H	4"	100	609	10
ME621-06	6"	150	813	10
ME621-06H	6"	150	813	10
ME621-07	7"	175	911	10
ME621-07H	7"	175	911	10
ME621-08	8"	200	929	10
ME621-10	10"	250	1200	10
ME621-10H	10"	250	1200	10
ME621-13	13"	330	1480	10
ME621-13H	13"	330	1480	10

## 1"ME821 1" Drive Extension Bar



Without Ball :  
ME821-07H, ME821-10H, ME821-13H

M7 NO.	Total Length		g	10
	inch	mm		
ME821-03	3"	75	727	10
ME821-06	6"	150	1330	10
ME821-07	7"	175	1520	10
ME821-07H	7"	175	1520	10
ME821-08	8"	200	1705	10
ME821-10	10"	250	2050	10
ME821-10H	10"	250	2050	10
ME821-12	12"	300	2382	10
ME821-13	13"	330	2550	10
ME821-13H	13"	330	2550	10

## 1/2"ME471M

Impact Hex Bit  
1/2" Drive Metric Size

M7 NO.	mm	Total Length		g	10
		mm	g		
ME471M04	4	78	71	10	
ME471M05	5	78	77	10	
ME471M06	6	78	81	10	
ME471M07	7	78	87	10	
ME471M08	8	78	95	10	
ME471M09	9	78	102	10	
ME471M10	10	78	108	10	
ME471M11	11	78	118	10	
ME471M12	12	78	128	10	
ME471M13	13	78	140	10	
ME471M14	14	78	149	10	
ME471M15	15	78	166	10	
ME471M16	16	78	177	10	
ME471M17	17	78	188	10	
ME471M18	18	78	202	10	
ME471M19	19	78	215	10	
ME471M20	20	78	173	10	
ME471M21	21	78	233	10	
ME471M22	22	78	194	10	



# IMPACT SOCKET

## 3/4" ME671M

Impact Hex Bits Socket  
3/4" Drive Metric Size



M7 NO.	Size	Total Length	Weight	Volume
	mm	mm	g	
ME671M10	10	100	490	----
ME671M12	12	100	510	----
ME671M14	14	100	520	----
ME671M17	17	100	540	----
ME671M19	19	100	600	----
ME671M21	21	100	610	----
ME671M22	22	100	620	----
ME671M24	24	100	690	----
ME671M27	27	100	720	----
ME671M30	30	100	830	----
ME671M32	32	100	850	----

## 3/4" ME671S

Impact Hex Bits Socket  
3/4" Drive Inch Size



M7 NO.	Size	Total Length	Weight	Volume
	inch	mm	g	
ME671S12	3/8"	100	480	----
ME671S14	7/16"	100	500	----
ME671S16	1/2"	100	510	----
ME671S18	9/16"	100	520	----
ME671S20	5/8"	100	530	----
ME671S22	11/16"	100	540	----
ME671S24	3/4"	100	600	----
ME671S26	13/16"	100	610	----
ME671S28	7/8"	100	620	----
ME671S30	15/16"	100	690	----
ME671S32	1"	100	680	----
ME671S34	1-1/16"	100	720	----
ME671S36	1-1/8"	100	740	----
ME671S38	1-3/16"	100	830	----
ME671S40	1-1/4"	100	850	----

## 1/2" ME904 1/2" Drive Locking Ring 1/2" Drive Locking Pin

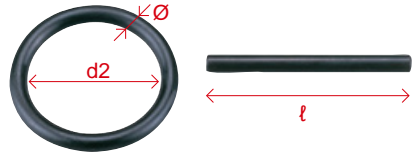

M7 NO.	Disp.	Ø	d2	l	Applied to socket sizes
		mm	mm	mm	
ME90424	Ring	3.5	19		8-19mm
ME90424	Pin	3		20	(3/16"-9/16")
ME90436	Ring	3.5	23		15-46mm
ME90436	Pin	3		25	(5/8"-1-1/4")

## 3/4" ME906 3/4" Drive Locking Ring 3/4" Drive Locking Pin

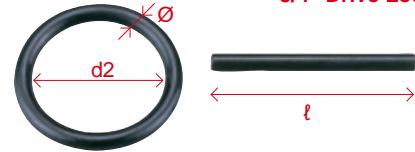

M7 NO.	Disp.	Ø	d2	l	Applied to socket sizes
		mm	mm	mm	
ME90627	Ring	3.5	33		17-30mm
ME90627	Pin	3		30	(11/16"-1-3/16")
ME90646	Ring	5.5	37		17-46mm
ME90646	Pin	4		35	(1-1/16"-1-13/16")
ME90650	Ring	5.5	44		48mm-65mm
ME90650	Pin	4		45	(1-7/8"-2-3/8")

## 1" ME908 1" Drive Locking Ring 1" Drive Locking Pin

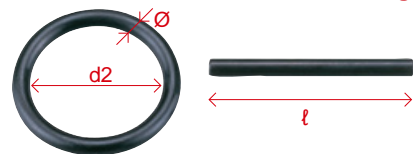

M7 NO.	Disp.	Ø	d2	l	Applied to socket sizes
		mm	mm	mm	
ME90836	Ring	5.5	48		19-70mm
ME90836	Pin	5		45	(3/4"-2-3/4")
ME90860	Ring	10	75		71-90mm
ME90860	Pin	5		75	(2-13/16"-3-1/2")

## AD-22/23/24

Magnetic Aluminum Rail

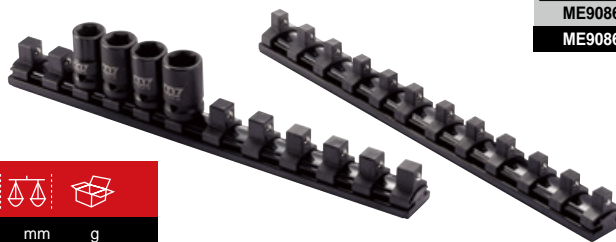

M7 NO.	Drive	Total Length	Weight	Volume	
	inch	inch	mm	mm	g
AD-2212	1/4"	12"	300	25	10
AD-2312	3/8"	12"	300	25	10
AD-2412	1/2"	12"	300	25	10
AD-2218	1/4"	18"	457	26	10
AD-2318	3/8"	18"	457	26	10
AD-2418	1/2"	18"	457	26	10

## 3/8" MB371S

3/8" Drive Bit Holder

M7 NO.	Drive	Hex	Weight	Volume
	inch	g		
MB371S08	3/8"	1/4"	43	10
MB471S08	1/2"	1/4"	76	10
MB471S10	1/2"	5/16"	78	10
MB471M10	1/2"	10 mm	80	10



## ME422

1/2" Drive Torque  
Extension Bar



M7 NO.	Color	Total Length	D	Torque	Weight	Volume
		mm	mm	Ft / Nm	g	
ME422-090	Yellow	194	9	65/90	236	10
ME422-110	Blue	194	11	80/110	231	10
ME422-122	Gray	194	12.2	100/135	258	10
ME422-137	White	194	13.7	120/160	300	10
ME422-151	Sky nature	194	15.1	140/190	306	10
ME422-103	Black	194	10.3	75/100	224	10
ME422-114	Beige	194	11.4	90/120	242	10
ME422-128	Orange	194	12.8	110/150	269	10

## AD-3511P Display Security Steel Wire Rope

## AD-3511T Hook Type Base

Hook Type Base With Card Display  
& Display Security Steel Wire Rope



### Contents :

#### AD-3511P :

- 1 x Display Security Steel Wire Rope
- 2x L Hex Wrench
- 1x Hex Socket Screws

#### AD-3511T :

- 1x Acrylic Card Case Hook Type Base



Item No.	Adaptor Type	Contents			
AD-3511	Europe	SY-211M	AD-3521	AD-3511T	
AD-3512	Japan	SY-221M	AD-3522	AD-3511T	
AD-3513	U.S.A	SY-231M	AD-3523	AD-3511T	

## AD-35 Complete Set Of Tool Base

Item No.	Adaptor Type	Contents			
AD-3501	Europe	SY-211M	AD-3521	AD-351	
AD-3502	Japan	SY-221M	AD-3522	AD-351	
AD-3501	U.S.A	SY-231M	AD-3521	AD-351	

## AD-36 Complete Set Of Tool Base

Item No.	Adaptor Type	Contents			
AD-3601	Europe	SY-211M	AD-3521	AD-305-41	
AD-3602	Japan	SY-221M	AD-3522	AD-305-41	
AD-3601	U.S.A	SY-231M	AD-3521	AD-305-41	

## AD-309 DISPLAY BOARD

- Nice m7 brand image is conducive to small space display hanging tools.
- Can also be used as a gift to the user to hang the tools.

Overall Size(mm)  
Width x Depth x Height

725 x 14 x 900  
weight:11.5kg



## AD-307 Wall Type Display Stand

- Powder Coating
- Attachment
- 1pc Brand Plate
- 2pcs Angled Steel Frame
- 2pcs Shelf
- 1pc Bottom Shelf
- 4pcs Steel Plate With Hole

Overall Size(mm)  
Width x Depth x Height

900 x 500 x 2230

## AD-351 Optional Item

## AD-361 Optional Item

Overall Size(mm)  
Width x Depth

280 x 910 mm



## AD-308 Tower Type Display Stand

### Tower Type Display Stand

- 1pc Transparent DM Shelf
- 2pcs Support Frame
- 1pc Bottom Shelf

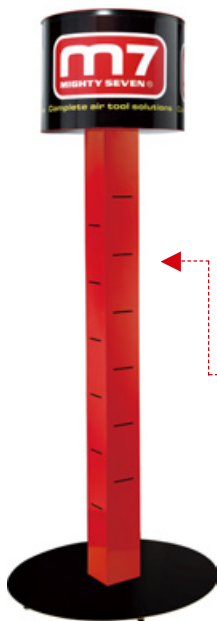

## AD-305-41 Optional Item

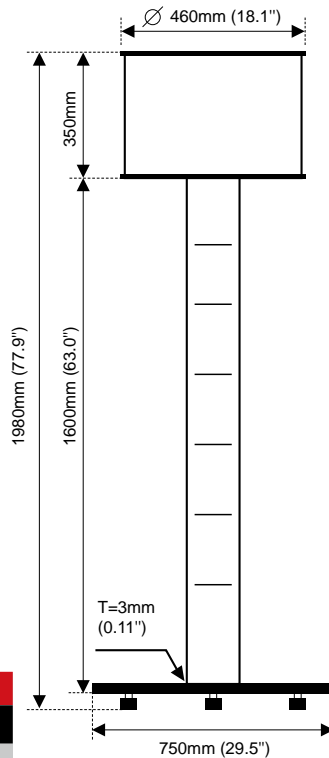
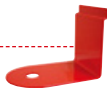

Package				
Contains	net weight kg	gross weight kg	length mm	width mm
Lamp Case Set	4.35	5.35	530 510	101
Display Pillar	8.0	9.0	930 330	180
Display Stand Bottom Plate	10.45	11.45	810 820	70

## ST-10C521 ST-10C522S

### user DIY assembled mobile working chair

- Color: red/black anti scratch paint
- Seat cushion materials: high graded artificial PVC leather with sponge
- Product sizes: long 350mm width 260mm height 240mm, excl.
- wheels Drawer height: 70mm
- Product feature: storage daily needed tools reduce squatting fatigue, movable willingly.



ST-10C521



ST-10C522  
1 Drawer Design



# DISPLAY CASE

## SF-306 / SF-604 SF-605

### Spare Parts Box

- greasy-resisting
- wearproof

Overall Size(mm)  
Width x Depth x Height

SF-306 303 x 106 x 253 (11.8"x4.1"x10")

SF-604 603 x 167 x 203 (23.7"x6.5"x8")

SF-605 603 x 123 x 153 (23.7"x4.8"x6")

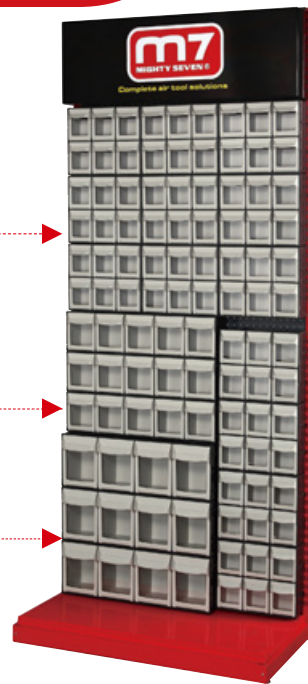

## AD-306

### Table Type Display Stand

- 1 pc Transparent DM shelf
- 2 pcs support frame
- 1 pc Bottom shelf
- 3 set (AD-3521/3522/3523)

Overall Size(mm)  
Width x Depth x Height

300 x 140 x 340



## AD-431

### 1/2" DR. Socket Shelf Set



## AD-201

### 1/2" DR. Socket Shelf Set



## SH-1001

### AIR TOOL HOLDER



## Accessories

### ZT-13-1 Forward

### ZT-13-2 Reverse

### TORQUE TEST MACHINE

Torque testing for maintaining pneumatic impact wrenches

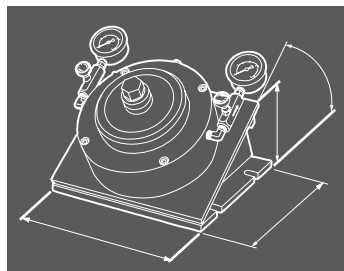

- Applicable Range: 50ft-lb ~ 2000ft-lb(70Nm ~ 2700Nm)
- Max. Torque: 3500 ft-lb(5000Nm)
- Applicable Size:SQ.DR-1/2" ~ 3/4"
- Measuring Direction:ZT-13-1Forward/ZT-13-2Reverse
- Screw Size:M32
- Length x Width:35cm\*30cm
- Weight:49KG



# ACCESSORIES

## NON-VACCUM VELCRO

Backing Face : velcro



Blister+Card

ITEM NO.	SIZE	Max R.P.M
QB-9302	2"	15000
QB-9303	3"	15000
QB-9305	5"	12000
QB-9306	6"	12000



## SIX HOLE

Backing Face : velcro  
velcro & vinyl are both available



Blister+Card

ITEM NO.	SIZE	Max R.P.M
QB-9315 (velcro)	5"	12000
QB-9315 (vinyl)	5"	12000
QB-9315 (velcro)	6"	12000
QB-9315 (vinyl)	6"	12000



## NON-VACCUM VINYL

Backing Face : vinyl



Blister+Card

ITEM NO.	SIZE	Max R.P.M
QB-9345	5"	12000
QB-9346	6"	12000



## FIFTEEN HOLE

Backing Face : velcro  
velcro & vinyl are both available

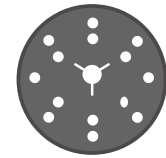

Blister+Card

ITEM NO.	SIZE	Max R.P.M
QB-9327 (velcro)	6"	12000
QB-9366 (vinyl)	6"	12000



**QB-922**  
**QB-923**  
Roll On Holder



**QB-922**  
2" Roll On Holder



**QB-923**  
3" Roll On Holder



ITEM NO.	Size	Max R.P.M	For M7 Item No.
QB-922	2"	30,000	QP-212 QP-213 QP-223
QB-923	3"	20,000	QP-625

**QB-9712K**  
**QB-9713K**

Stripping Disc  
Use on QB-922 & QB-9  
Roll-on holder



5 pcs / 1 SET

ITEM NO.	SIZE	R.P.M
QB-9712K	2"	15,000
QB-9713K	3"	15,000



Bag+Card

# QB-9337M QB-9337S

7" Sanding Pad



ITEM NO.	Size	Max R.P.M	Thread Size	For M7 Item No.
QB-9337M	7"	15,000	M14*2.0	QB-307 QB-327
QB-9337S	7"	15,000	5/8**11	QB-317

## PAD DIE Series

5 pcs / 1 SET  
Use on QB-922 & QB-923



Blister+Card

ITEM NO.	Size	PS.	Max R.P.M	For M7 Item NO.
QB-9702k-24	2"	Grit:#24	30,000	QP-212 QP-212N QB-625 QB-0618
QB-9702k-40		Grit:#40		
QB-9702k-60		Grit:#60		
QB-9702k-80		Grit:#80		
QB-9702k-100		Grit:#100		
QB-9702k-120		Grit:#120		
QB-9702k-150		Grit:#150		
QB-9702k-180		Grit:#180		
QB-9702k-240		Grit:#240		
QB-9703k-24		3"		
QB-9703k-40	Grit:#40			
QB-9703k-60	Grit:#60			
QB-9703k-80	Grit:#80			
QB-9703k-100	Grit:#100			
QB-9703k-120	Grit:#120			
QB-9703k-150	Grit:#150			
QB-9703k-180	Grit:#180			
QB-9703k-320	Grit:#320			



## PAD DIE Series

5 pcs / SET  
Use on QB-922 & QB-923



Blister+Card

ITEM NO.	Size	PS.	Max R.P.M	For M7 Item NO.
QB-9712-YL	2"	Yellow-Coarse #80	30,000	QP-212 QP-212N QB-625 QB-0618
QB-9712-RD	2"	Red-Medium #150		
QB-9712-BL	2"	Blue-Fine #300		
QB-9713-YL	3"	Yellow-Coarse #80		
QB-9713-RD	3"	Red-Medium #150		
QB-9713-BL	3"	Blue-Fine #300		



## QB-9434 FOR GLOBAL QB-9434U FOR USA ONLY

Eraser Wheel  
Available with  
QB-812T



## QB-9444 FOR GLOBAL QB-9444U FOR USA ONLY

Eraser Wheel  
Available with  
QB-802 & QB-812





# ACCESSORIES

## QB-95 SERIES

Wool Bonnet PAD



Bag+Card

ITEM NO.	Size	PS. .	For M7 Item NO.
0QB-9512	2"	Velcro	QB-9302
0QB-9513	3"	Velcro	
0QB-9515	5"	Velcro	QB-9303
0QB-9517	7"	Velcro	QB-9305
0QB-9507	7"	Tie Cords	QB-9315

## QB-94 SERIES

Sponge



Bag+Card

ITEM NO.	Size	PS.	Thickness	For M7 Item NO.
0QB-9402	2"	Yellow / Rough	25mm	QB-9302 QB-9303 QB-9305 QB-9306 QB-9315 QB-9316 QB-9327
0QB-9422	2"	White / Medium	25mm	
0QB-9403	3"	Yellow / Rough	25mm	
0QB-9413	3"	White / Medium	25mm	
0QB-9404	4"	Yellow / Rough	25mm	
0QB-9424	4"	White / Medium	25mm	
0QB-9405	5"	Yellow / Rough	25mm	
0QB-9425	5"	White / Medium	25mm	
0QB-9406	6"	Yellow / Rough	25mm	
0QB-9426	6"	White / Medium	25mm	
0QB-9407	7"	Yellow / Rough	25mm	
0QB-9427	7"	White / Medium	25mm	

## QB-9211A / B [SET]

Grinder Stone Set  
A(3mm shank)B(1/8" shank)

Available with

QA-633Q QA-611 QA-632Q  
QA-111 QA-211 QA-231Q  
QA-311 QA-313 QA-315



Blister+Card

## QB-9213A / B [SET]

Grinder Stone Set  
A(6mm shank)B(1/4" shank)

Available with

M7 All Air Die Grinder



Blister+Card

## QB-911 [SET]

## QB-912 [SET]

Abrasive Cloth Belt

QB-91108

QB-91110

Available with  
For QB-311 / QB-321

QB-91208

QB-91210

Available with  
For QB-312 / QB-322 / QB-322C



Bag+Card



ITEM NO.	Belt Size		For M7 Item NO.
QB-91108	10mm x 330mm #80	10Pcs/1 Set	QB-311 QB-321
QB-91110	10mm x 330mm #100	10Pcs/1 Set	
QB-91208	20mm x 520mm #80	10Pcs/1 Set	QB-322 QB-322C QB-312
QB-91210	20mm x 520mm #100	10Pcs/1 Set	



## QB-904 / QB-905 / QB-907

Grinding Wheel Materials: Aluminum Oxide





ITEM NO.	Specification	 	For M7 Item NO.
0QB-904	100 x 6 x 16 4" x 1/4" x 5/8" 102mm	25 / 200	(QB-904) : QB-104, QB-114, QB-124, QB-134, QB-144, QB-154, QB-164, QB-194, QB-194N, QB-194L, QB-7114
0QB-905	125 x 6 x 22 5" x 1/4" x 7/8" 127mm	25 / 200	(QB-905) : QB-115, QB-125, QB-135, QB-145, QB-155, QB-165, QB-185, QB-195, QB-7115
0QB-907	180 x 6 x 22 7" x 1/4" x 7/8" 128mm	25 / 200	(QB-907) : QB-107, QB-117, QB-177, QB-187, QB-197

## QB-913 / QB-914

Cut-off Wheel



ITEM NO.	Specification	 	For M7 Item NO.
0QB-913	75 x 1.5 x 10 3" x 1/16" x 3/8" 76mm	25 / 200	QC-213 / QC-213T / QC-253
0QB-914	100 x 1.5 x 10 4" x 1/16" x 3/8" 102mm	25 / 200	QC-213 / QC-213T / QC-253 / QC-264

## QD-932P

32T Saw Blade  
Bi-Metal Material

Available with  
QD-221 & QD-291

10 pcs / box

Blister+Card



## QD-924P

24T Saw Blade  
Bi-Metal Material

Available with  
QD-221 & QD-291

10 pcs / box

Blister+Card



Blister+Card

## QD-905P

4 Pieces File Set clamshell pack  
For QD-291 / 230  
Blister+Card



## QD-906P

5 Pieces File Set clamshell pack  
For QD-221  
Blister+Card



Blister+Card

## QM-901

Universal repairing kit for  
Auto-Transmission shaft boot  
Available with QM-1125



## PC-901

Adjustable Toeque Air Tapping Adapter  
HEX:8mm

For: Air Drill / Electricity Drill  
Cordless Drill / Drill Machine  
Blister+Card



# ACCESSORIES

## SN-9101 / SN-9103 SN-9201 / SN-9203

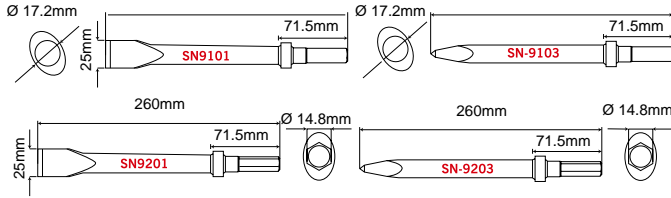

## SW-12(1/4") SW-13(3/8")

Mini Lubricator  
Install on the air inlet to provide automatic lubrication  
8c.c. lubricating oil capacity



Box

Blister

## PA-MC Automatic Mandrel Collection

**CAPACITY**  
3/32" (2.4mm) 220pcs  
1/8" (3.2mm) 160pcs  
5/32" (4.0mm) 110pcs  
3/16" (4.8mm) 80pcs



## PE-MC Standard Safety Tip



## SB-902

0-90° Angle Adjustable One  
Touch Chuck Adaptor

Available with  
SB Series TYRE INFLATOR



## SB-912

0-90° Angle Adjustable One  
Touch Chuck Adaptor

Available with  
SB Series TYRE INFLATOR



## SC-2B

Quick Change Retainer

Available with  
For SC-21 / SC-22 /  
SC-31 / SC-34 SERIES



## SC-2A

Retainer



## MA-412M1719



Double Sided Socket  
2" Extended Anvil matching special double  
sided socket 17mm & 19mm specifically for  
automotive tyres.

## MA-412M2122



Double Sided Socket  
2" Extended Anvil matching special double  
sided socket 21mm & 22mm specifically for  
automotive tyres.

## MA-412S2426



Double Sided Socket  
2" Extended Anvil matching special double  
sided socket 24mm & 26mm specifically for  
automotive tyres.

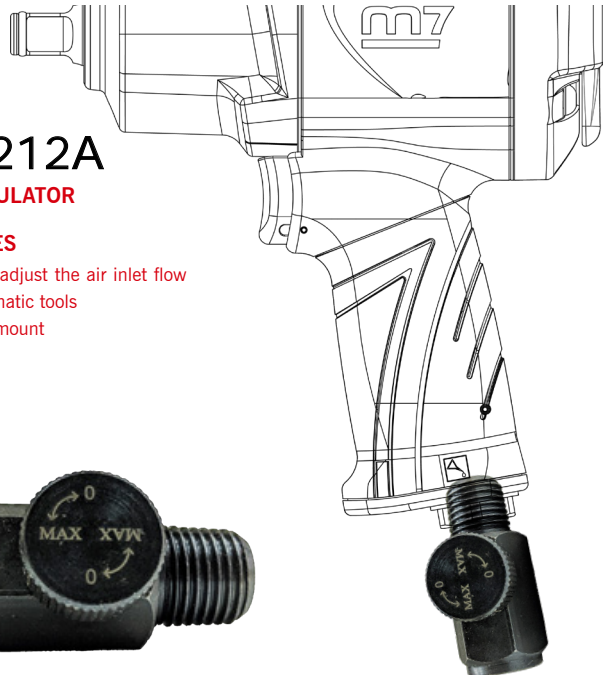

**SZ-212A**  
AIR REGULATOR

**FEATURES**

- Used to adjust the air inlet flow of pneumatic tools
- Easy to mount



**SN-124 SN-268**  
**SN-128 SN-288**



Needle Set

**SN-288**  
(12 Needle Set) 3 x 125mm  
Available with  
SN-1288

**SN-268**  
(19 Needle Set) 3 x 180mm  
Available with  
SN-1268 / 2110 / 1368

**SN-124**  
(24 Needle Set) 3 x 180mm  
Available with  
SN-2124

**SN-128**  
(28 Needle Set) 3 x 180mm  
Available with  
SN-2128

**SO-10**  
Lubrication



**SG-101**  
Lubrication Kit



**SO-10T**  
Lubrication Kit



BOX

**QK-Series**

Air Knife Blade

For QK-111 / QK-121 / QK-131 / PN-250 / PN-280

QK-111P51



QK-111P52



QK-111P53



QK-111P54



QK-111P50



QK-111P08



QK-2090



QK-2063



QK-2036



Blister

- 0QK-2030P - QK-111P08
- 0QK-1057P - QK-111P50
- 0QK-3018P - QK-111P51
- 0QK-3036P - QK-111P52
- 0QK-1008P - QK-111P54



# ACCESSORIES

## SC-415P CHISEL SET SC-425P CHISEL SET

- SC-415 - Chisel Set / 175mmL / Round
- SC-425 - Chisel Set / 175mmL / Hex

Available with

SC-331C / SC-341C / SC-332C / SC-342C  
SC-211C / SC-221C / SC-212C / SC-222C

-  Flat Chisel  
SC-4101 Round / SC-4201 Hex
-  Cutting Chisel  
SC-4102 Round / SC-4202 Hex
-  Tapered Punch  
SC-4103 Round / SC-4203 Hex
-  Ripping Chisel  
SC-4104 Round / SC-4204 Hex
-  Tail Pipe Cutter  
SC-4105 Round / SC-4205 Hex

## CHISEL

For SN-31 / SC-32 SERIES



Blister+Card

## QB-9773K19

### 3" Polishing Sponge Kit

MAX : 15,000 R.P.M

For QP-113 / QP-123 / QP-213 / QP-223



Blister+Card

#### SHANK TYPE

QB-9773K19A : 6mm  
QB-9773K19B : 1/4"

#### CONTENTS :

Shank x 1 PC (A or B)  
3" Sanding Pad x 1PC  
3" Sanding Sponge x 6PCS  
3" Sanding Paper x 10PCS  
3" Polishing Sponge x 2PCS

## QB-9752K07

### 2" Felt Pad Conditioning Disc Kit

MAX : 20,000 R.P.M

For QP-113 / QP-123 / QP-213 / QP-223



Blister+Card

#### SHANK TYPE

QB-9752K07A : 6mm  
QB-9752K07B : 1/4"

#### CONTENTS :

2" Felt Pad x 6PCS

## QB-9762K07

### 2" Surface Pad Conditioning Disc Kit

MAX : 20,000 R.P.M

For QP-113 / QP-123 / QP-213 / QP-223



Blister+Card

#### SHANK TYPE

QB-9762K07A : 6mm  
QB-9762K07B : 1/4"

#### CONTENTS :

Shank x 1 PC (A or B)  
2" Stripping Disc x 2PCS

#### 2" CONDITIONING DISC :

Red x 2PCS  
Grey x 2PCS

## QB-9742K20

### 2" Surface Sanding Kit

MAX : 30,000 R.P.M

For QP-212 / QP-213 / QP-223 / QP-625



Blister+Card

#### SHANK TYPE

QB-9742K20A : 6mm  
QB-9742K12B : 1/4"

#### CONTENTS :

Shank x 1 PC (A or B)  
2" Rollon Holder x 1PC  
2" Pad Die x 15PCS  
2" Sanding Disc x 3PCS

## QB-9742K12

### 2" Surface Sanding Kit

MAX : 30,000 R.P.M

For QP-212 / QP-213 / QP-223 / QP-625



Blister+Card

#### CONTENTS :

Shank x 1 PC (A or B)  
2" Rollon Holder x 1PC  
2" Pad Die x 6PCS  
2" Sanding Disc x 3PCS  
2" Stripping Disc x 1PC

## QB-9743K12

### 3" Surface Sanding Kit

MAX : 20,000 R.P.M

For QP-212 / QP-213 / QP-223 / QP-625



Blister+Card

#### SHANK TYPE

QB-9743K12A : 6mm  
QB-9743K12B : 1/4"

#### CONTENTS :

Shank x 1 PC (A or B)  
3" Rollon Holder x 1PC  
3" Pad Die x 6PCS  
3" Sanding Disc x 3PCS  
3" Stripping Disc x 1PC



## QB-9303K04

### 3" Sander / Buffer Versatility Kit

Thread : 5/16" x 24

MAX : 15,000 R.P.M

For QP-113 / QP-123 / QP-213 / QP-223



Blister+Card

#### CONTENTS :

3" Sanding Pad x 1PC  
3" Foam Yellow x 1PC  
3" Foam White x 1PC  
3" Wool Bonnet x 1PC

Max R.P.M : 15,000

Backing Face :  
Velcro Available

## QB-974K12

### 2" & 3" Surface Sanding Kit

2" Max : 30,000 R.P.M

3" Max : 20,000 E.P.M

For QP-212 / QP-213 / QP-223 / QP-625



Blister+Card

#### SHANK TYPE

QB-974K12A : 6mm

QB-974K12B : 1/4"

#### CONTENTS :

Shank x 2 PC (A or B)

2" Rollon Holder x 1PC

3" Rollon Holder x 1PC

2" Sanding Disc x 4PCS

3" Sanding Disc x 4PCS

## QB-9743K20

### 3" Surface Sanding Kit

MAX : 20,000 R.P.M

For QP-212 / QP-213 / QP-223 / QP-625



Blister+Card

#### SHANK TYPE

QB-9743K20A : 6mm

QB-9743K20B : 1/4"

#### CONTENTS :

Shank x 1 PC (A or B)

3" Rollon Holder x 1PC

3" Pad Die x 15PCS

3" Sanding Disc x 3PCS

# Sanding Paper Series

Velcro / Self-Adhesive

Six hole / Non-Vacuum

5 pcs or 10 pcs / 1 SET

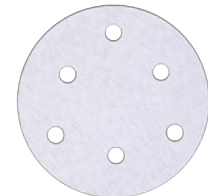
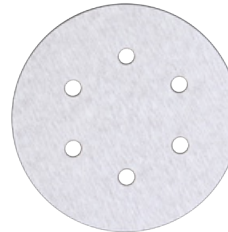

### Self-Adhesive

### Velcro

ITEM NO.	Size	PS.	Velcro / Self-AD	For M7 Item NO.	Holes	pcs / set
0QB-9913S-08K10	3"	Grit:#80	Self-Adhesive	QP-113	Non	10
0QB-9913S-15K10		Grit:#150				
0QB-9913S-18K10		Grit:#180				
0QB-9913S-32K10		Grit:#320				
0QB-9913S-40K10		Grit:#400				
0QB-9915S-08K5	5"	Grit:#80		QB-41		
0QB-9915S-15K5		Grit:#150				
0QB-9915S-18K5		Grit:#180				
0QB-9915S-32K5		Grit:#320				
0QB-9915S-40K5		Grit:#400				
0QB-9916S-08K5	6"	Grit:#80	QB-43			
0QB-9916S-15K5		Grit:#150				
0QB-9916S-18K5		Grit:#180				
0QB-9916S-32K5		Grit:#320				
0QB-9916S-40K5		Grit:#400				
0QB-9905S-08K5	5"	Grit:#80	QB-52	6		
0QB-9905S-15K5		Grit:#150				
0QB-9905S-18K5		Grit:#180				
0QB-9905S-32K5		Grit:#320				
0QB-9905S-40K5		Grit:#400				
0QB-9906S-08K5	6"	Grit:#80	QB-58			
0QB-9906S-15K5		Grit:#150				
0QB-9906S-18K5		Grit:#180				
0QB-9906S-32K5		Grit:#320				
0QB-9906S-40K5		Grit:#400				

ITEM NO.	Size	PS.	Velcro / Self-AD	For M7 Item NO.	Holes	pcs / set
0QB-9913V-08K10	3"	Grit:#80	Velcro	QP-113	Non	10
0QB-9913V-15K10		Grit:#150				
0QB-9913V-18K10		Grit:#180				
0QB-9913V-32K10		Grit:#320				
0QB-9913V-40K10		Grit:#400				
0QB-9915V-08K5	5"	Grit:#80		QB-41		
0QB-9915V-15K5		Grit:#150				
0QB-9915V-18K5		Grit:#180				
0QB-9915V-32K5		Grit:#320				
0QB-9915V-40K5		Grit:#400				
0QB-9916V-08K5	6"	Grit:#80	QB-43			
0QB-9916V-15K5		Grit:#150				
0QB-9916V-18K5		Grit:#180				
0QB-9916V-32K5		Grit:#320				
0QB-9916V-40K5		Grit:#400				
0QB-9905V-08K5	5"	Grit:#80	QB-52	6		
0QB-9905V-15K5		Grit:#150				
0QB-9905V-18K5		Grit:#180				
0QB-9905V-32K5		Grit:#320				
0QB-9905V-40K5		Grit:#400				
0QB-9906V-08K5	6"	Grit:#80	QB-58			
0QB-9906V-15K5		Grit:#150				
0QB-9906V-18K5		Grit:#180				
0QB-9906V-32K5		Grit:#320				
0QB-9906V-40K5		Grit:#400				

# AIR ADAPTOR QUICK COUPLINGS

AIR ADAPTOR QUICK COUPLINGS

## SY-2001M

Air Inlet 1/4"  
360° Rotatable Adaptor



## SY-2002M

Air Inlet 1/4"  
Air Regulator & 360°  
Rotatable Adaptor











## SY-2011M





Air Inlet 1/4"  
360° Rotatable Adaptor



Blister+Card

### SY-M SY-F Air Adaptor / Quick Couplings

Item No.	Thread Type	Thread Size	Type	Picture
SY-211M SY-211F	Male Female	1/4" PT	Europe	 
SY-221M SY-321M	Male	1/4" PT 3/8" PT	Japan	 
SY-221F SY-321F	Female	1/4" PT 3/8" PT		
SY-231M SY-231F	Male Female	1/4" NPT	U.S.A	 
SY-251M SY-351M	Male	1/4" PT 3/8" PT	France	 
SY-251F SY-351F	Female	1/4" PT 3/8" PT		

Item No.	Thread Type	Thread Size	Type	Picture
SY-210M SY-210F	Male Female	1/4" PT	Europe U.S.A	 Female  Male
SY-220M SY-320M	Male	1/4" PT 3/8" PT	Japan	 Female  Male
SY-220F SY-320F	Female	1/4" PT 3/8" PT		



Blister+Card

## Composite Quick Coupling

Item No.	Thread Type	Thread Size	Type	Picture
SY-0213M	Male	1/4" PT	Europe	
SY-0313M		3/8" PT		
SY-0413M		1/2" PT		
SY-0223M	Male	1/4" PT	Japan	
SY-0323M		3/8" PT		
SY-0423M		1/2" PT		
SY-0233M	Male	1/4" PT	U.S.A France	
SY-0333M		3/8" PT		
SY-0433M		1/2" PT		

Item No.	Thread Type	Thread Size	Type	Picture
SY-1213F	Female	1/4" PT	Europe	
SY-1313F		3/8" PT		
SY-1413F		1/2" PT		
SY-1223F	Female	1/4" PT	Japan	
SY-1323F		3/8" PT		
SY-1423F		1/2" PT		
SY-1233F	Female	1/4" PT	U.S.A France	
SY-1333F		3/8" PT		
SY-1433F		1/2" PT		

Item No.	Thread Type	Thread Size	Type	Picture
SY-2213P	----	5x8 PU	Europe	
SY-2313P		6.5x10 PU		
SY-2413P		8x12 PU		
SY-2223P	----	5x8 PU	Japan	
SY-2323P		6.5x10 PU		
SY-2423P		8x12 PU		
SY-2233P	----	5x8 PU	U.S.A France	
SY-2333P		6.5x10 PU		
SY-2433P		8x12 PU		

Item No.	Thread Type	Thread Size	Type	Picture
SY-3113H	----	10SH 1/4"	Europe	
SY-3213H		20SH 5/16"		
SY-3313H		30SH 3/8"		
SY-3413H		40SH 1/2"		
SY-3123H	----	10SH 1/4"	Japan	
SY-3223H		20SH 5/16"		
SY-3323H		30SH 3/8"		
SY-3423H		40SH 1/2"		
SY-3133H	----	10SH 1/4"	U.S.A France	
SY-3233H		20SH 5/16"		
SY-3333H		30SH 3/8"		
SY-3433H		40SH 1/2"		

AIR ADAPTOR QUICK COUPLINGS

# POWER BIT

## 1/4" POWER BIT (PHILLIPS HEAD)

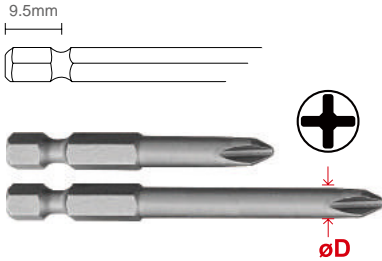

"OVERALL LENGTH(mm)"	SIZE	ITEM NO.	ØD(mm)
25	2	MD50125P2A	6
	2	MD50125P2R	6
50	0	MD10150P0A	3
	1	MD10150P1A	4.5
	2	MD10150P2A	6
	3	MD10150P3A	6
70	1	MD10170P1A	4.5
	2	MD10170P2A	6
	3	MD10170P3A	6

## 1/4" POWER BIT (POZIDRIV HEAD)

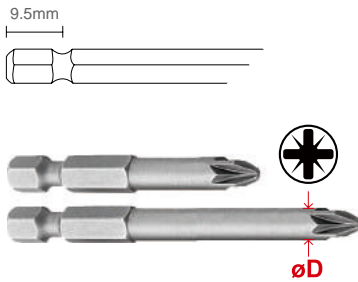

"OVERALL LENGTH(mm)"	SIZE	ITEM NO.	ØD(mm)
25	2	MD50125Z2A	6
50	0	MD10150Z0A	3
	1	MD10150Z1A	4.5
	2	MD10150Z2A	6
	3	MD10150Z3A	6
70	1	MD10170Z1A	4.5
	2	MD10170Z2A	6
	3	MD10170Z3A	6

## 1/4" POWER BIT (STAR TAMPER HEAD)

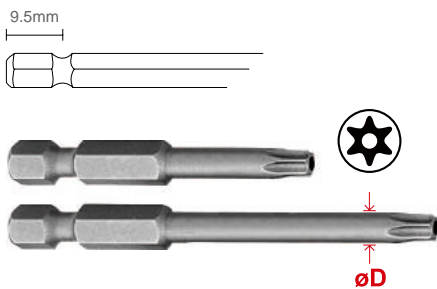

"OVERALL LENGTH(mm)"	SIZE	ITEM NO.	ØD(mm)
90	10	MD10190TT10A	4
	15	MD10190TT15A	4
	20	MD10190TT20A	4.8
	25	MD10190TT25A	4.8
	30	MD10190TT30A	6

"OVERALL LENGTH(mm)"	SIZE	ITEM NO.	ØD(mm)
50	6	MD10150TT06A	3.2
	7	MD10150TT07A	3.2
	8	MD10150TT08A	3.2
	9	MD10150TT09A	3.2
	10	MD10150TT10A	4
	15	MD10150TT15A	4
	20	MD10150TT20A	4.8
	25	MD10150TT25A	4.8
	27	MD10150TT27A	6
	30	MD10150TT30A	6
70	40	MD10150TT40A	6.3
	6	MD10170TT06A	3.2
	7	MD10170TT07A	3.2
	8	MD10170TT08A	3.2
	9	MD10170TT09A	3.2
	10	MD10170TT10A	4
	15	MD10170TT15A	4
	20	MD10170TT20A	4.8
	25	MD10170TT25A	4.8
	27	MD10170TT27A	6
30	MD10170TT30A	6	
40	MD10170TT40F	6.3	
45	MD10170TT45E	8	
50	MD05170TT50E	9.1	



## 1/4" POWER BIT (DOUBLE PHILLIPS HEAD)

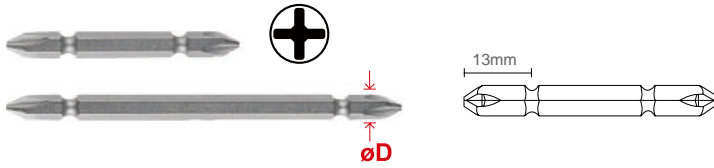

"OVERALL LENGTH(mm)"	SIZE	ITEM NO.
65	1	MD10165P1P1A
	2	MD10165P2P2A
	3	MD10165P3P3A
110	1	MD101110P1P1A
	2	MD101110P2P2A
	3	MD101110P3P3A

## 1/4" POWER BIT (HEX HEAD)

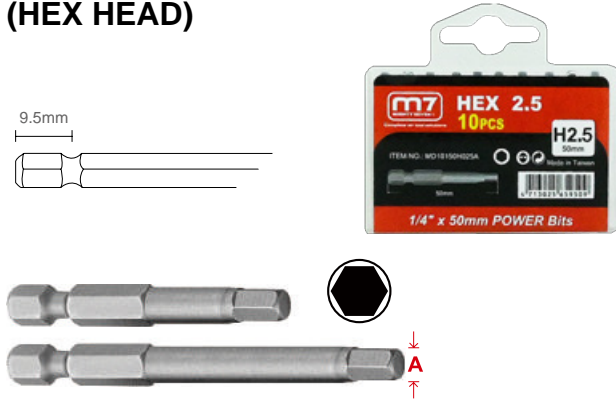

"OVERALL LENGTH(mm)"	A(mm)	ITEM NO.
150	2.5	MD101150H025A
	3	MD101150H030A
	4	MD101150H040A
	5	MD101150H050A
	6	MD101150H060A

"OVERALL LENGTH(mm)"	A(mm)	ITEM NO.
50	1.5	MD10150H015A
	2	MD10150H020A
	2.5	MD10150H025A
	3	MD10150H030A
	4	MD10150H040A
	5	MD10150H050A
	6	MD10150H060F
	7	MD10150H070E
	8	MD10150H080E
	10	MD10150H100E
70	1.5	MD10170H015A
	2	MD10170H020A
	2.5	MD10170H025A
	3	MD10170H030A
	4	MD10170H040A
	5	MD10170H050A
	6	MD10170H060F
	7	MD10170H070E
	8	MD10170H080E
	10	MD05170H100E

## 1/4" POWER BIT (STAR HEAD)

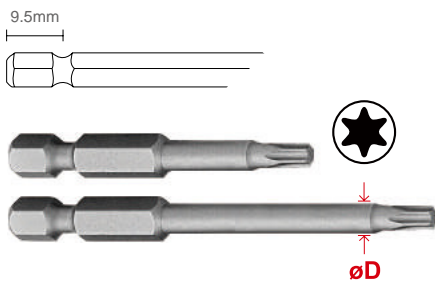

"OVERALL LENGTH(mm)"	SIZE	ITEM NO.	øD(mm)
25	20	MD10125T20A	4.8

"OVERALL LENGTH(mm)"	SIZE	ITEM NO.	øD(mm)	
50	6	MD10150T06A	3.2	
	7	MD10150T07A	3.2	
	8	MD10150T08A	3.2	
	9	MD10150T09A	3.2	
	10	MD10150T10A	4	
	15	MD10150T15A	4	
	20	MD10150T20A	4.8	
	25	MD10150T25A	4.8	
	27	MD10150T27A	6	
	30	MD10150T30A	6	
	40	MD10150T40F	7	
	45	MD10150T45E	8	
	50	MD05150T50E	9.1	
	70	6	MD10170T06A	3.2
		7	MD10170T07A	3.2
8		MD10170T08A	3.2	
9		MD10170T09A	3.2	
10		MD10170T10A	4	
15		MD10170T15A	4	
20		MD10170T20A	4.8	
25		MD10170T25A	4.8	
27		MD10170T27A	6	
30		MD10170T30A	6	
40		MD10170T40F	7	
45		MD10170T45E	8	
50		MD10170T50E	9.1	
45		MD08170T45E	8	
50		MD05170T50E	9.1	

# MERCHANDISE

## ZC-201R

T-shirt



## ZC-201B

T-shirt



## ZC-501

T-shirt



SIZE	S	M	L	XL	2XL
	3XL	4XL	3L	4L	5L

## ZB-812

Anti-vibration Glove

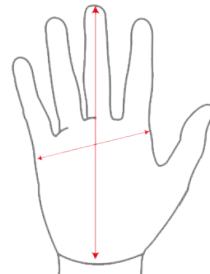

**Palm length :**

Distance between middle finger to bottom of the palm

**Palm width :**

Distance between left side and right side of the palm

CE EN388 2121X

Item Description	length(cm)	wide(cm)
M	21.3	10.5
L	22	11
XL	22.7	11.5
XXL	23.4	12

## ZB-9156

LED Pen light



LED x 4pcs

No. 4 battery x 3pcs included

## ZB-814

Half Finger Blade Cut Resistance Glove



## ZC-202-1

Baseball Cap



## ZC-203

Sports Cap



## ZB-306

Pen(Stylus)

- Pen with touch function



## ZB-307

Pen



## ZB-604

USB drive

- 8GB USB Flash Drive



### ZC-111

TOOL Bag  
37\*24\*23cm



### ZC-112

TOOL Bag  
(rubber base)  
40\*22\*30cm



### ZH-104

Mini usb LED Flashlight



### ZF-01

WING PROTECTOR COVER



### ZC-301

Stickers



100x112mm

### ZC-107

Bag



### ZF-02

WING PROTECTOR COVER



### ZC-302

Stickers



200x110mm

### ZM-101

27" Automatic umbrella



### ZG-101

Watch



### ZC-303

Stickers



199x106mm

### ZB-211

Mug



### ZE-03

Kneeling Pad



### ZC-304

Stickers



288x156mm

# CORDLESS TOOLS

## NEW PRODUCT

**BRUSHLESS**  
**DD-101**  
CORDLESS DRILL



**BRUSHLESS**  
**DH-101**  
CORDLESS IMPACT DRILL



Note : This tool is attached an auxiliary handle

**BRUSHLESS**  
**DD-101A [ KIT ]**  
CORDLESS DRILL



### CONTENTS

- 2pcs 18V 5.0 Ah Lithium-ion
- 1pc Lithium-ion Battery Charger
- 1pc Auxiliary Handle

**BRUSHLESS**  
**DH-101A [ KIT ]**  
CORDLESS IMPACT DRILL



### CONTENTS

- 2pcs 18V 5.0 Ah Lithium-ion
- 1pc Lithium-ion Battery Charger

	Chuck Size	Max Torque	Free Speed	Impact Rate	Net Weight		Set Weight		Torque Setting	Max Drill Capacity	
	mm	N.m	R.P.M	I.P.M	LBS	kg	LBS	kg		Wood	Steel
DD-101	13	90	Low 0-500 / High 0-2000	-----	3.02	1.37	12.8	5.8	23+1	50	13
DH-101	13	90	Low 0-500 / High 0-2000	0-8000 / 0-32000	3.19	1.45	13.0	5.9	23+1+1	60	13



**NEW PRODUCT**

**BRUSHLESS**  
**DG-501**  
CORDLESS ANGLE GRINDER



● Note : The grinding wheel is not supplied along with the tool

**BRUSHLESS**  
**DG-501A [ KIT ]**  
CORDLESS ANGLE GRINDER



**CONTENTS**

- 2pcs 18V 5.0 Ah Lithium-ion
- 1pc Lithium-ion Battery Charger
- Note : The grinding wheel is not supplied along with the tool

Stroke Size	Pad Dia	Free Speed	Overall Length	Net Weight		Set Weight	
				LBS	kg	LBS	kg
M14*P2.0	5"(125)	8000	11-7/32"(285)	4.8	2.2	13.6	6.2

**DOS-501**  
Cordless Random Orbital Sander



**DOS-501A [ KIT ]**  
Cordless Random Orbital Sander



**CONTENTS**

- 2pcs 18V 5.0 Ah Lithium-ion
- 1pc Lithium-ion Battery Charger
- Packaging: Color Box

Pad Dia	Orbit	Free Speed	Overall Length	Net Weight		Set Weight	
				LBS	kg	LBS	kg
5"(125)	3.0	7000-11000	11-13/16"(300)	2.7	1.23	8.8	4.0

**BRUSHLESS**  
**DCS-101**  
Cordless Circular Saw



**BRUSHLESS**  
**DCS-101A [ KIT ]**  
Cordless Circular Saw



**CONTENTS**

- 2pcs 18V 5.0 Ah Lithium-ion
- 1pc Lithium-ion Battery Charger
- Packaging: Color Box

Blade Arbor Size	Blade Dia	No Load Speed	Cutting Capacity	Cutting Capacity	Bevel Capacity	Overall Length	Net Weight		Set Weight	
							LBS	kg	LBS	kg
16	7-1/4"(185)	4500	2-3/8" (60.5)	1-3/4" (46)	0-56°	13-3/8"(340)	7.51	3.41	12.3	5.61

CORDLESS TOOLS

# CORDLESS TOOLS

**DB-1850P** 18V 5.0Ah Li-ion Battery  
**DB-1825** 18V 5.0Ah Li-ion Battery



**DB-1850P**

**DB-1825**

**DC-18A**  
 Cordless 18V Battery Charger  
 18V Li-ion Battery Charger  
 ( For DB-1825/DB-1850/DB-1850P )



**DFL-101**  
 CORDLESS LED FLOOD LIGHT



Key Spec:  
 + Bulb Type : LED  
 + Lumens :  
 180° 450 LM  
 360° - Low 550 LM  
 360° - High 850 LM  
 + Runtime :  
 180° 18 Hrs  
 360° - Low 20 Hrs  
 360° - High 10 Hrs

**DS-10202A [ KIT ]**  
 CORDLESS IMPACT DRIVER

- + Max. torque 100 NM
- + Quick charge-up in 30 minutes
- + Battery x 2pcs included for a longer period of usage
- + LED lamp to light up the working area
- + Battery applicable to all m7 12V cordless models.

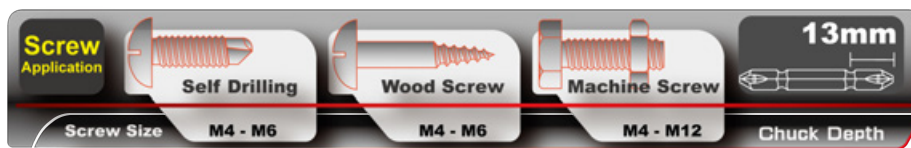

	Chuck size	Max. drill capacity	Bolt capacity	Battery	Max. torque	No load speed	Impact rate	Net Weight		Set Weight	
	inch / mm	mm(steel / wood)	---	Li-ion Ah	Nm	rpm	bpm	LBS	kg	LBS	kg
<b>DS-10202</b>	1/4" / 6.35	---	M4 ~ M12	2.0	100	0~2200	0~3000	2.2	1.0	4.0	1.82

**DJ-1835**  
 CORDLESS NAILER GUN

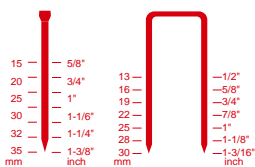

**AJ-1835**  
 ELECTRIC NAILER GUN

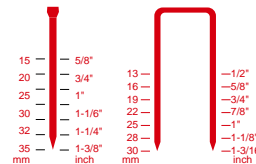

	Nail Type	Crown	Shank	Length	Gauge	Dimensions	Load Capacity	Weight
		mm	Thickness / width mm					
<b>AJ-1835</b>	Brad	---	1.0/1.25	15~35	18	231 x 68 x 272	100	1.9
	Staple	5.8	1.0/1.25	13~30	18			
<b>DJ-1835</b>	Brad	---	1.0/1.25	15~35	18	265 x 82 x 245	100	3.3
	Staple	5.8	1.0/1.25	13~30	18			

BRUSHLESS

Motor



# DW-601

CORDLESS IMPACT WRENCH

**1900 Nm**

**Patented**  
Shock Absorption Body



BRUSHLESS

Motor



# DW-601A [ KIT ]

CORDLESS IMPACT WRENCH



contents:

+ Accessory : 2pcs 5.0Ah Li-ion battery+ 1pc charger

BRUSHLESS

Motor



# DW-401

CORDLESS IMPACT WRENCH

**3** AUTO STOP MODE



BRUSHLESS

Motor



# DW-401A [ KIT ]

CORDLESS IMPACT WRENCH



contents:

+ Accessory : 2pcs 5.0Ah Li-ion battery+ 1pc charger

BRUSHLESS

Motor



# DW-402

CORDLESS IMPACT WRENCH



BRUSHLESS

Motor



# DW-402A [ KIT ]

CORDLESS IMPACT WRENCH



contents:

+ Accessory : 2pcs 5.0Ah Li-ion battery+ 1pc charger

+ Packaging: BMC

	Square Drive	Bolt Capacity	Max Torque		No Load Speed	Impact Rate	Net Weight		Set Weight	
	Inch(mm)		FT-LB	Nm	R.P.M	I.P.M	LBS	kg	LBS	kg
						<b>ipm</b>				
DW-601	3/4"(19)	M10-M27	1400	1900	0-900 / 0-1000 / 0-1800	0-1800 / 0-2000 / 0-2200	7.4	3.37	16.7	7.6
DW-401	1/2"(12.7)	M16	600	813	0-1100 / 0-1600 / 0-2200	0-1500 / 0-2500 / 0-3000	3.3	1.48	12.5	5.67
DW-402	1/2"(12.7)	M10-M24	1250	1700	0-900 / 0-1000 / 0-1700	0-1800 / 0-2000 / 0-2200	7.27	3.33	16.7	7.6



# CORDLESS TOOLS

**BRUSHLESS** Motor   
**DRS-101**  
 CORDLESS RECIPROCATING SAW



**BRUSHLESS** Motor   
**DRS-102**  
 CORDLESS RECIPROCATING SAW



**BRUSHLESS** Motor   
**DRS-101A [ KIT ]**  
 CORDLESS RECIPROCATING SAW



**Contents:**  
 + Accessories : 5.0Ah battery x 2pcs; charger x 1pc  
 +Packaging: Color Box

**BRUSHLESS** Motor   
**DRS-102A [ KIT ]**  
 CORDLESS RECIPROCATING SAW



**Contents:**  
 + Accessories : 5.0Ah battery x 2pcs; charger x 1pc

	Stroke Length	Stroke Per min.	Overall Length	Net Weight		Set Weight		Cut Capacity	
	mm	S.P.M	Inch (mm)	LBS	kg	LBS	kg	Wood	Steel
DRS-101	29	3100	16-1/7 (410)	5.95	2.7	11.8	5.37	200	20
DRS-102	25	3100	13-3/13 (410)	3.92	1.78	13.1	5.93	160	16

**DG-585**  
 CORDLESS ANGLE GRINDER



● Note : The grinding wheel is not supplied along with the tool

**DG-585502A [ KIT ]**  
 CORDLESS ANGLE GRINDER

**Accessories:**  
 5.0Ah battery x 2pcs  
 Charger x 1pc  
 Guard spanner x 1pc  
 Aux handle x 1pc  
 Packaging: color boxcharger x 1pc



● Note : The grinding wheel is not supplied along with the tool

	Stroke Size	Pad Dia	Free Speed	Overall Length	Net Weight		Set Weight	
		Inch (mm)	R.P.M	Inch (mm)	LBS	kg	LBS	kg
DG-585	M14*P2.0	5"(125)	8000	11-7/32"(285)	4.8	2.2	12.3	5.6



## DJS-101 CORDLESS JIG SAW



SUITABLE FOR  
BOTH T & U SHANK

## DJS-101A [ KIT ] CORDLESS JIG SAW



**Contents:**  
+ Accessories: 5.0Ah battery x 2pcs; charger x 1pc  
+ Packaging: Color Box

	Stroke Length	Stroke Per min.	Overall Length	Net Weight		Set Weight		Cut Capacity		
	mm	S.P.M	Inch (mm)	LBS lb	kg kg	LBS lb	kg kg	Wood	Aluminium	Steel
DJS-101	25.4	2200	16-1/7 (410)	5.9	2.7	9.7	4.4	2-1/2"(63)	3/8"(9.53)	1/4"(6.0)

## DW-1840 CORDLESS IMPACT WRENCH



## DW-18502A [ KIT ] CORDLESS IMPACT WRENCH



**CONTENTS**  
● 2pcs 18V 5.0 Ah Lithium-ion  
● 1pc Lithium-ion Battery Charger

	Square Drive	Max. drill capacity	Bolt capacity	Battery	Max. torque	No load speed	Impact rate	Weight		Set Weight	
	inch / mm	mm(steel / wood)	---	Li-ion Ah	Nm	rpm	bpm	LBS	kg	LBS	kg
DW-1840	1/2" / 12.7	---	M6 ~ M24	5.0	1220	0~1900	0~2200	7.0	3.2	14.3	6.5

## BRUSHLESS DS-201 CORDLESS IMPACT DRIVER



**3 AUTO STOP MODE**



## BRUSHLESS DS-201A [ KIT ] CORDLESS IMPACT DRIVER



**CONTENTS**  
● 2pcs 18V 5.0 Ah Lithium-ion ● 1pc Lithium-ion Battery Charger



	Chuck Size	Bolt Capacity	Max Torque	No Load Speed	Impact Rate	Net Weight		Set Weight	
	mm		FT-LB(Nm)	R.P.M	I.P.M	LBS lb	kg kg	LBS lb	kg kg
DS-201	1/4"(6.35)	M12	150(203)	0-1100 / 0-1900 / 0-2800	0-1200 / 0-2350 / 0-3300	2.8	1.28	12.2	5.53





CORDLESS TOOLS

# CORDLESS TOOLS